



Thermo Scientific Orion 2117LL

Low Level Chloride Analyzer

UM-268880-001 • Revision B • January 2017

Thermo
SCIENTIFIC

© 2013-2017 Thermo Fisher Scientific Inc. All rights reserved. All trademarks are the property of Thermo Fisher Scientific Inc. and its subsidiaries. Specifications, terms and pricing are subject to change. Not all products are available in all countries. Please consult your local sales representative for details.

No part of this publication may be reproduced, transmitted, transcribed, stored in a retrieval system, or translated into any language or any computer language, in any form or by any third party, without the prior written permission of Thermo Fisher Scientific.

Disclaimer

Thermo Fisher Scientific does not accept any responsibility for any damage caused to its products by unauthorized personnel. Use of non-Thermo Scientific™ reagents and/or replacement parts will void all warranties.

Contents

Section 1 General Information	1
Introduction	1
Features and Benefits	1
Principles of Operation	2
Low Level Chloride Electrode Response	4
Principles of Calibration	4
Offline Calibration	5
Three Point Calibration	5
Fluidics Diagram	6
Description of 2117LL Analyzer Components	7
Two Channel Analyzer Configurations	8
Section 2 Analyzer Preparation	9
Mounting and Plumbing Instructions	10
Sample Requirements	11
Electrical Wiring	11
Safety Requirements	12
Warning Labels and Locations	12
Wiring the Analyzer	13
Terminal Assignments	15
Electrode Wiring Assignments	16
Installation of Reagent and Diffusion Tubing	17
Cooler Connection Instructions	18
Installation of New Electrode Cables	19
Installation of a New Chloride Electrode	19
Installation of the ATC Probe	20
Installation of a New Reference Electrode	20
Section 3 Analyzer Operation	22
Description of Basic Controls	22
Description of Keypad Icons	23
Use of the Setup Mode	24
Setup Mode Overview	26
Shutdown and Start-Up Procedure	48
Section 4 Calibration	50
Calibration Setup	50
3 Point Calibration	50
OffLine Calibration	51
Flow Cell Operation	52
Rinsing the Flow Cell	53
Dynamic Calibrator Operation	54

Dynamic Calibrator and Syringe Setup	54
Calibration Abort Steps	55
Calibration Error Codes	55
Calibration At Custom Concentrations Using DYN	57
Dynamic Calibrator Check	57
Offline Calibration Procedure	58
Section 5 Analyzer Maintenance	60
Maintenance Schedule	60
Weekly Maintenance	60
Monthly Maintenance	61
Bi-Monthly Maintenance	62
Yearly Preventive Maintenance	63
Section 6 Troubleshooting	65
Diagnostics Mode	67
Slope Problems	72
Troubleshooting Matrix	73
Error/Event Codes	75
Resetting the Analyzer	77
Serial Number and Software Revision	78
Service and Repair	79
Section 7 Customer Service	81
Notice of Compliance	81
Statement of Conformity	82
WEEE Compliance	83
Terms and Conditions	83
Appendix	86
Mounting Dimensions	86
Specifications	87
Ordering Information	90

1

SECTION 1

General Information

Introduction

This user guide covers the operation, maintenance and troubleshooting for the Thermo Scientific™ Orion® 2117LL low level chloride analyzer, which incorporates the software features of a three point and offline calibration.

The Orion 2117LL has a limit of detection of 5 ppb. Used to monitor boiler water and boiler blow down, the Orion 2117LL is an indicator that could detect costly condenser leaks. A refrigeration unit cools the sample down below 12°C which enables the sensor to detect chloride at extremely low levels without additional manipulation of the sample. This system includes a double junction ceramic frit reference electrode designed to provide outstanding long term performance; and a chloride sensor known for its superior accuracy at low levels.

Features and Benefits

The Thermo Scientific Orion 2117LL chloride analyzer is ideal for measuring and monitoring the critical chloride levels in feedwater, boiler water or economizer inlet. With limited maintenance requirements and low reagent usage, the 2117LL analyzer provides the highest level of performance with ease of use.

- Measurement of chloride in water using premium Thermo Scientific Orion ion selective electrode (ISE) technology.
- Accurate and precise measurements in the range of 5 ppb to 10 ppm for chloride:
 - Reliable measurements and a wide measurement range with selectable resolution.
 - Measures chloride levels in aqueous solutions quickly, accurately and economically.

- Premium reference and sensing electrodes:
 - Superior accuracy and stability over a wide concentration range.
- Advanced flow cell design:
 - Automatic sample handling and contamination control with no moving parts.
- Patented scrolling marquee:
 - Intuitive menu-driven, digital user interface.
- Data log of previous measurements and calibration:
 - View measurement, calibration and error history.
- Self diagnostics:
 - Ease of maintainability.
- Password protection:
 - Security and peace of mind for your operation.
- Auto-ranging electronics with an easy to read backlit LCD display:
 - Analyzer determines the best range.

Principles of Operation

Figure 1 shows a block diagram of sample flow through the analyzer.

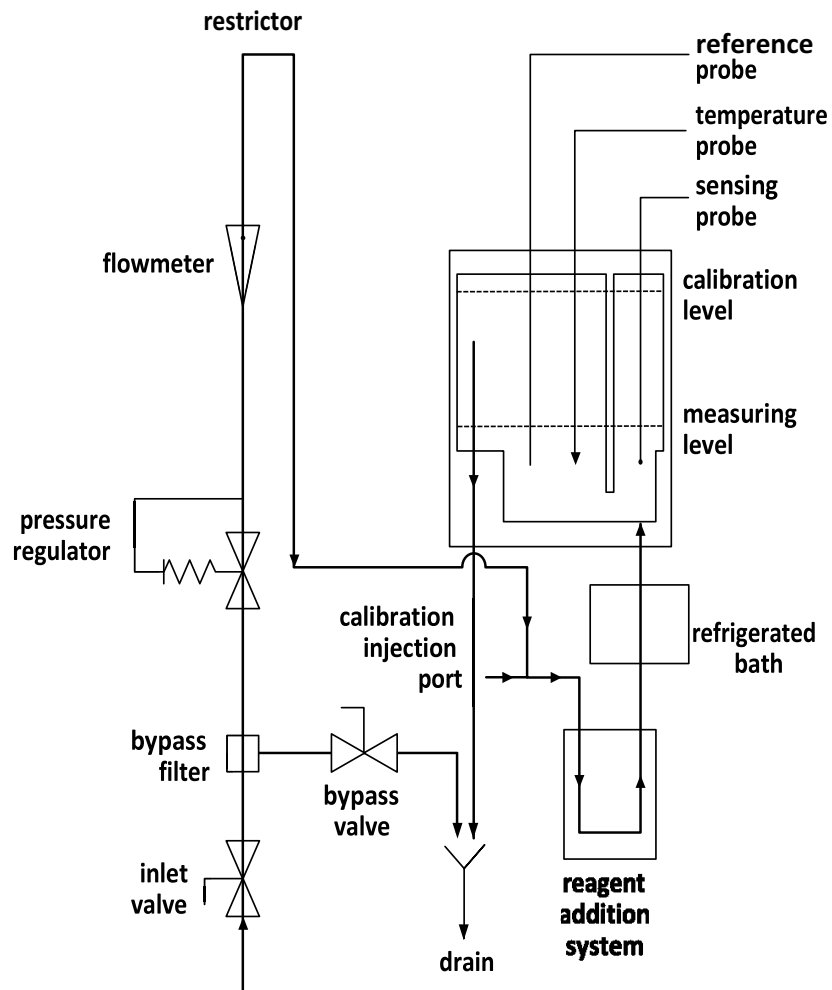
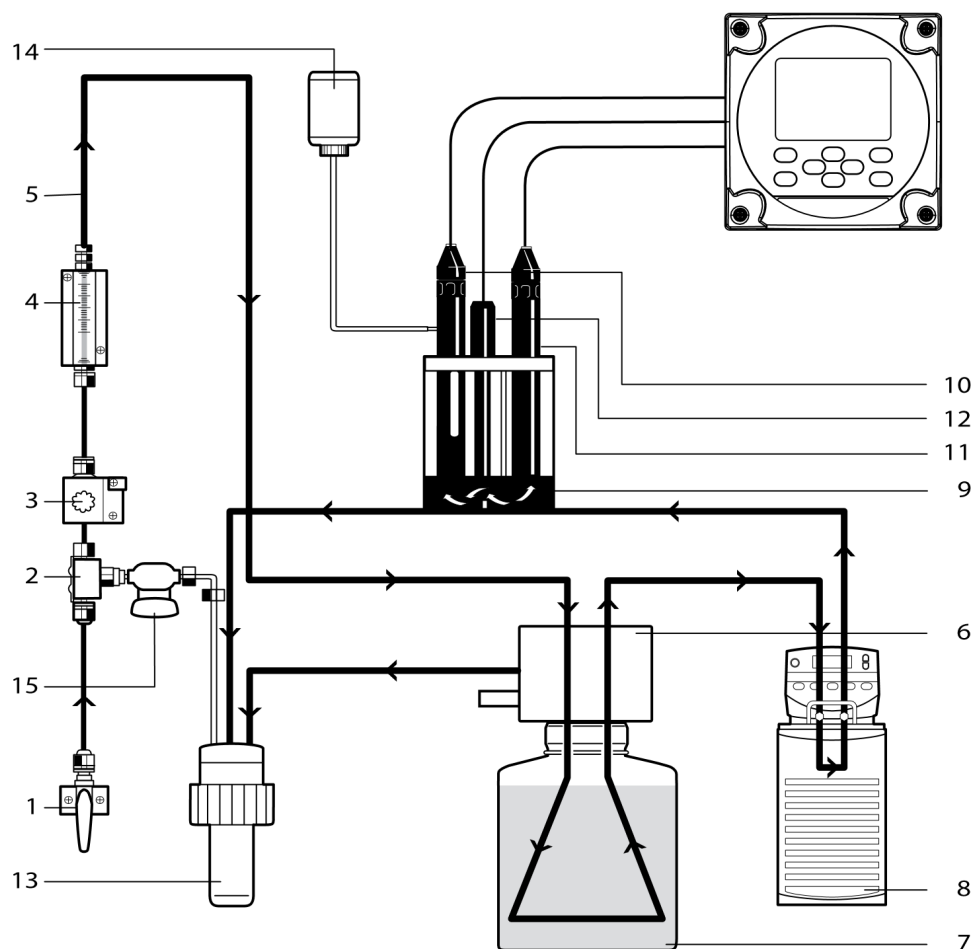

Figure 1: Block Diagram of Sample Flow

Figure 2 illustrates the sample flow during normal operation.

As shown in Figure 2, the sample (temperatures up to 45 °C) enters the 2117LL analyzer and passes through the inlet valve, 1, bypass filter, 2, pressure regulator, 3, flow meter, 4, and restrictor tubing, 5, and then flows through the fluid connector block, 6, into a reagent diffusion bottle, 7, where the sample is acidified. Once acidified, the sample flows to a refrigeration unit, 8, that cools the sample to between 5 and 12 °C \pm 1 °C and the sample is then transferred to the flow cell, 9, through insulated tubing. Within the flow cell the cooled sample passes the chloridesensing electrode, 10, and reference electrode, 11, in the top portion of the flow cell. The sample then flows past the temperature probe, 12, into an atmospheric drain, 13.

Figure 2: Flow During Normal Operation



1	Inlet Valve	9	Flow Cell
2	Bypass Filter	10	Sensing Electrode
3	Pressure Regulator	11	Reference Electrode
4	Flowmeter	12	Temperature Probe
5	Flow Restrictor Tubing Bottle	13	Drain
6	Fluids Block	14	Electrolyte Reservoir
7	Reagent Diffusion Bottle	15	Bypass Valve
8	Refrigerated Bath		

Low Level Chloride Electrode Response

The chloride electrode responds to change in chloride ion concentration. The sensing surface of the electrode consists of a mixture of a metal amalgam and a sparingly soluble chloride salt of the metal. In samples free of mercury ions, the potential of the electrode is determined by the solubility of the salt, which depends on the temperature and the chloride concentration of the sample. In order to achieve the low detection limit, the analyzer incorporates a cooling system to reduce the sample temperature prior to measurement. The analyzer also constantly updates temperature corrections from temperature measured by the ATC probe.

Principles of Calibration

To best ensure the accuracy of chloride measurement in the whole specified concentration range from extremely low to relatively high levels, a three-point two-segment calibration algorithm is implemented. Under the algorithm, three chloride standard concentrations are used for calibration; the first standard may be chloride-free (0 ppb). The first segment calibration uses the low and the mid concentrations following a two-point linear calibration of potential (mV) versus concentration (ppb); the second segment calibration uses the mid and the high concentrations following a two point linear calibration of potential (mV) versus logarithm of concentration (logC). Depending on the measured potential value, either the first segment or the second segment calibration will be used to read the sample concentration.

The 3-point calibration procedure using default standard concentrations of 0, 100, and 1000 ppb makes measurements in the entire range feasible, with measurements within 5 to 1000 ppb being the most accurate. By calibrating in a narrower range, accuracy may be further improved. For example, by calibrating using three standards of 0, 80, 200 ppb, accuracy in the low range may be enhanced.

The electrode response can be characterized by the following equations:

$$\text{Low levels (<100 ppb): } E = E^0(T) + S_1(T) * (C - C_2)$$

$$\text{High levels (>100 ppb): } E = E^0(T) + S_2(T) * \log(C/C_2)$$

E = measured stable potential

$E^0(T)$ = A temperature dependent potential value

$S_1(T)$ = Temperature dependent slope value of the first segment

$S_2(T)$ = Temperature dependent slope value of the second segment

C = Concentration of chloride ions

C_2 = Concentration of chloride ions of the mid calibration standard

The analyzer also offers a choice for offline calibration that allows the operator to adjust the calibration to values determined by alternative methods used in their laboratory.

Offline Calibration

The offline calibration feature of 2117LL analyzer allows the operator to adjust the analyzer to values determined by alternate methods used in their laboratory, such as ion chromatography and colorimetric method. It is essentially a one point calibration. To perform an offline calibration, a sample is taken from the bypass of the analyzer; the sample value is stored in memory; the sample is analyzed by an alternate method of choice; the previously stored reading is adjusted to the lab method result and the analyzer is then returned to the analysis mode. The term “offline calibration” refers only to the fact that a sample from 2117LL analyzer bypass is taken “offline” for laboratory analysis; in fact, no downtime is experienced during the procedure and the analyzer remains online throughout the procedure.

Three Point Calibration

This procedure provides maximum calibration accuracy and requires the use of a dynamic calibrator (Cat. No. 15DC15 for 115 V or Cat. No. 15DC20 for 220 V). In addition to calculation of electrode E_0 , as is done in offline calibration procedure, this procedure determines the electrode slope.

To perform a dynamic three point calibration, the 2117LL analyzer is first connected to a chloride free sample stream. This can be taken as the first standard of zero chloride. An appropriate standard is then prepared. The supplied syringe is filled with the standard and mounted on the dynamic calibrator. The dynamic calibrator is then mounted near the analyzer and the syringe tubing is connected to the standard injection port. By adjusting the dynamic calibrator pump settings, two different flow rates produce two known standards diluted into the sample background. By pressing the appropriate keys on the analyzer when prompted, the analyzer completes the calibration.

Fluidics Diagram

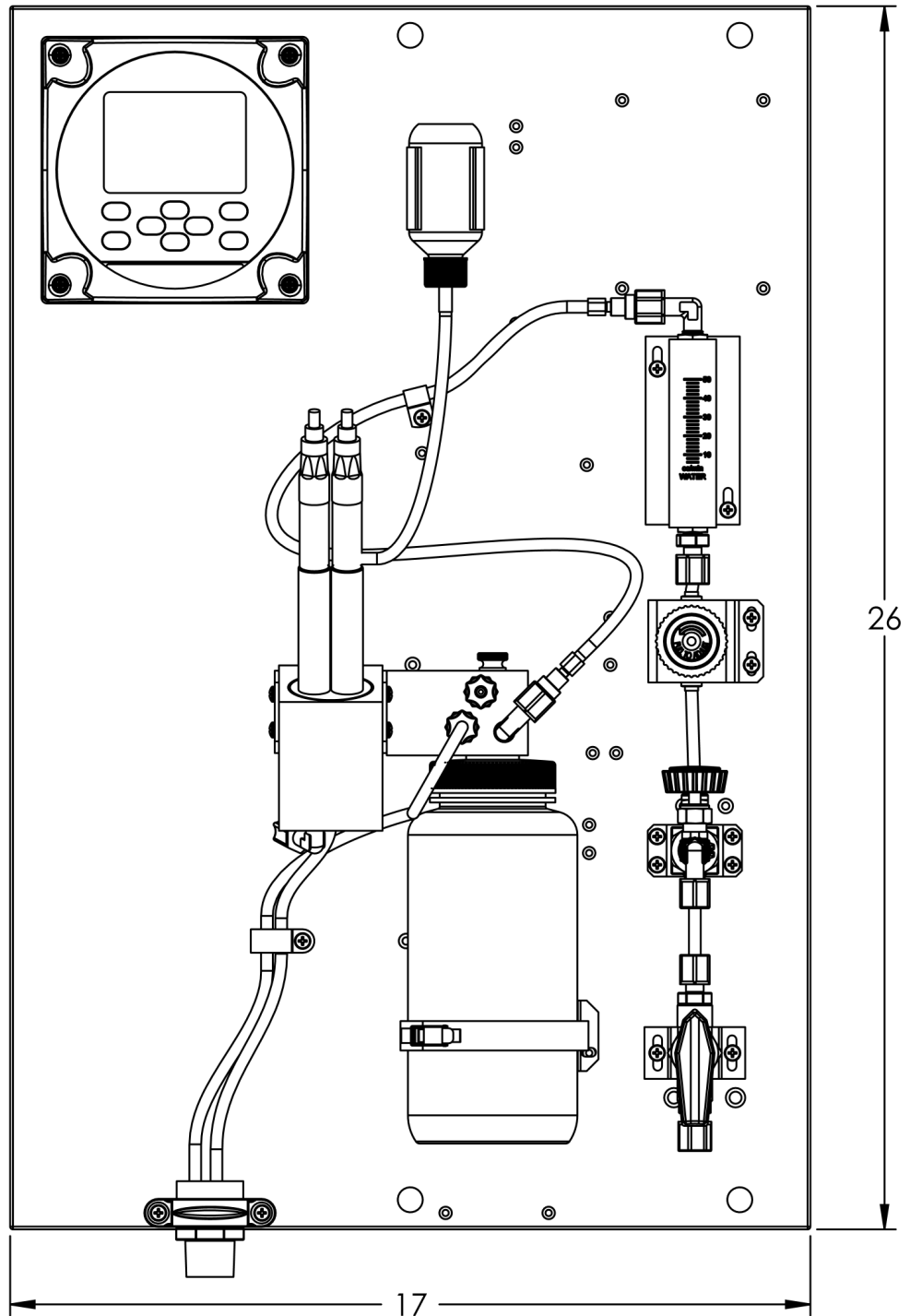

Description of 2117LL Analyzer Components

Sample Inlet Valve - Accepts the sample stream via a 1/4 inch NPTF connector. The operator must supply the sample with a pressure of 8 to 100 psig and a sample flow rate to the analyzer of 50 mL/minute minimum.

Bypass Filter Assembly - A 60 micron stainless steel filter traps particulate matter in the sample stream.

Pressure Regulator - Adjusts flow on the incoming sample stream.

Flow Valve - Used to turn off the flow to the flow cell.

Flow Meter - Measures the sample flow rate, a 40 mL/minute nominal flow is required through the analyzer.

Flow Restrictor Tubing - Maintains a steady sample flow rate in conjunction with the pressure regulator.

Fluid Connector Block - Connects the reagent diffusion bottle to the sample stream and flow cell assembly.

Reagent Bottle - Acidifies the sample by means of passive diffusion.

Refrigerated Bath - Cools the sample stream to below 10 °C.

Flow Cell - Contains the reference electrode, sensing electrode, ATC probe and sample measurement reservoir.

Chloride Electrode - Senses chloride ions in the sample stream and produces an electrical potential dependent on sample concentration. Must be placed on the left hand side of the flow cell.

Reference Electrode - Provides a constant reference potential and completes the measurement circuit. Must be placed on the right hand side of the flow cell.

ATC Probe - Measures the sample temperature and inputs the data to the microprocessor for automatic temperature compensation (ATC).

Drain - Atmospheric drain prevents back pressure on the reference electrode located behind the reagent bottle.

Electrolyte Reservoir - Provides a constant flow of electrolyte solution through the reference electrode for maximum stability.

Bypass Valve - Used to redirect the flow.

LED Display - Provides digital readouts of concentration, temperature, millivolts and error codes.

Keypad - Consists of five mode keys, four prompt indicator lights, two scroll keys and one key for entering data. Mode and error indicators are also incorporated on the keypad.

On/Off Switch - Controls all power to the electronics.

Standard Injection Port - Allows connection of dynamic calibrator tubing to the fluid connector block during a three point calibration.

Thumbscrew - Supports the reagent diffusion bottle.

Compression Fitting - Connects the flow restrictor tubing to the flow meter.

Status Indicator - Two LED Lights that illuminate according to current status of analyzer.

Green Light - Indicates that system is in correct working condition.

Yellow Light - Indicates a warning, system in hold or that maintenance is required.

Red Light - Indicates that something is seriously wrong.

Reagent Bottle - Contains an acid reagent to adjust sample pH.

Note: When either the yellow or red LED is lit, there may be an entry in the diagnostics mode that indicates the error. The logging feature must be initiated in the setup mode. Refer to Section 3, Use of the Setup Mode for instructions.

Two Channel Analyzer Configurations

A pH/ORP module or conductivity module can be added by the operator to the second channel of the Thermo Scientific Orion 2117LL low level chloride analyzer for the ultimate flexibility in measurement capabilities. The 2100 series pH/ORP and conductivity analyzers provide accurate and reliable measurements in ultra pure water as well as the harshest industrial environments. Combined with decades of superior Thermo Scientific Orion sensor technology, our systems provide rapid results with complete stability.

Cat. No.	Description
2100PH2	Second channel module for pH/ORP
2100CD2	Second channel module for conductivity

When a pH/ORP module or conductivity module is installed on the second channel of the 2117LL low level chloride analyzer, refer to the *Thermo Scientific Orion 2100 Series pH/ORP Analyzer and Conductivity Analyzer User Guide* for detailed instructions on operating the pH/ORP or conductivity analyzer. Visit www.thermofisher.com/water to download any of the 2100 series analyzer user guides.

2

SECTION 2 Analyzer Preparation

WARNING: The instructions provided in this userguide are recommendations from the manufacturer to ensure safe and correct operation of the analyzer. If the analyzer is not used as recommended by the manufacturer this can lead to incorrect operation or injury.

Unpacking the Analyzer

Thermo Scientific Orion analyzers are assembled, tested and packaged with great care. Refer to Figure 3.

Report any obvious damage of shipping container to carrier and hold for inspection. The carrier (not Thermo Fisher Scientific) is responsible for any damage incurred during shipment.

1. Open the outer box. Remove the top two foam corner support pieces.
2. Open the inner box. This box should contain the analyzer and ATC temperature probe, chloride electrode box, reference electrode box, the options kit and user guide CD.
3. Remove the cardboard retaining shell by sliding it over the entire mounting board and the analyzer.
4. Carefully remove the entire mounting board with analyzer from the inner box.

Note: Do not lift or pull the analyzer by the fluidics or the electronic components. Use the back panel to lift the analyzer system.

5. Unbolt the analyzer from the mounting board by removing the four mounting bolts with a 9/16" wrench. These bolts may be discarded.
6. Carefully place the analyzer at a convenient location until proper installation can be completed.

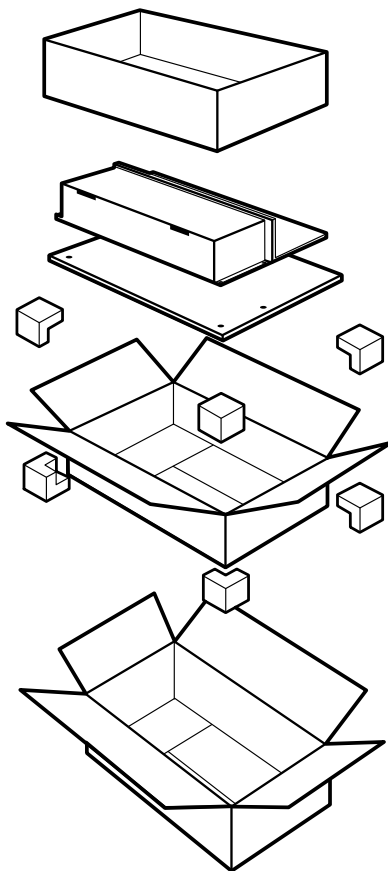

Figure 3: Unpacking the Analyzer

Mounting and Plumbing Instructions

Refer to the Appendix, Mounting Dimensions section.



WARNING: Do not connect power prior to the mounting and plumbing of the analyzer.

Recommendations

- Select a site for the analyzer that allows it to be permanently bolted with ample height for atmospheric drain operation. Be sure that there is ready access to the electronic controls, calibration port and electrodes.
- The analyzer location must permit connections to a sample line, drain and AC power supply and any connections for output devices.
- The analyzer should be mounted as close to the sampling point as possible. This ensures the fastest possible response to a changing sample condition. Refer to the Appendix, Sample Conditions section.

- For proper flow cell operation, the analyzer must be installed straight and level upon its mounting location.
- The cooler should be located on the floor or a suitable stand less than six feet from the analyzer's electrode chamber.

Instructions

1. Prepare the mounting holes. Carefully lift the analyzer and bolt it into place. Do not lift the analyzer by holding on to any of the plumbing or fluid handling components.
2. Connect a waste line to the outlet of the analyzer, which is 3/4 NPT male. The waste line should be connected to a drain of sufficient capacity, 0.5 inch (1.27 cm) OD is recommended.
3. Connect a sample line to the inlet of the analyzer, which is 1/4 NPT female. It is recommended that a shutoff valve be installed at the sampling point.
4. The analyzer must be mounted and leveled vertically for proper operation.

Sample Requirements

Additional information is listed in the Appendix, Specifications section.

Sample inlet connection – 1/4" NPTF. If particulate matter is present in the sample, pre-filtration is necessary. The 60 micron stainless steel filter located after inlet valve will remove moderate amounts of particulates.

Flow rate – 40 mL/minute (nominal).

Pressure – 8 to 100 psig. Consult Technical Support for details on sample handling if the pressure is outside of this range.

Temperature – Temperature must be between 5 and 45 °C.

Chloride level – Chloride levels are read directly in ppb or ppm, when calibrated with Thermo Scientific Orion standard.

Sample alkalinity – Sample alkalinity should be less than 50 ppm CaCO₃ equivalent. For higher sample alkalinity, contact Technical Support.

Electrical Wiring

The warning icon highlights important information that should be strictly followed when using the analyzer for your own safety. Failure to follow these instructions may result in injuries.



WARNING: Read and observe the following safety recommendations.

Safety Requirements

- Prior to wiring, a switch or circuit breaker for disconnecting the analyzer from power supply should be installed.
 - The switch should be in close proximity to the analyzer and with easy reach of the user.
 - The switch should be marked as the disconnecting device for the analyzer.
- To reduce the risk of shock hazard, disconnect the power prior to opening the analyzer.
- Before connecting the analyzer to the main, make sure that the voltage lies within either range: 100 to 120 V, 200 mA or 200 to 240 V, 100 mA; 50 / 60 Hz AC.
- Cutting off the power by disconnecting power source will not reset the analyzer. This analyzer incorporates a non-volatile memory and will maintain calibration and settings after power failure. Battery power is supplied to the display for the date and time functions.
- If a repair is required, or to arrange Return Material Authorization, call Technical Support or contact your local authorized dealer.
- Installation and wiring of the analyzer may only be carried out in accordance with applicable local and national codes per this user guide.
- Be sure to observe the technical specifications and input ratings.

Warning Labels and Locations



WARNING: The following section provides important information that should be strictly followed when using the analyzer for your own safety. Failure to follow these instructions may result in injuries.

The safety warning icons are used in two locations on the analyzer.

- Faceplate – Refer to Figure 4.

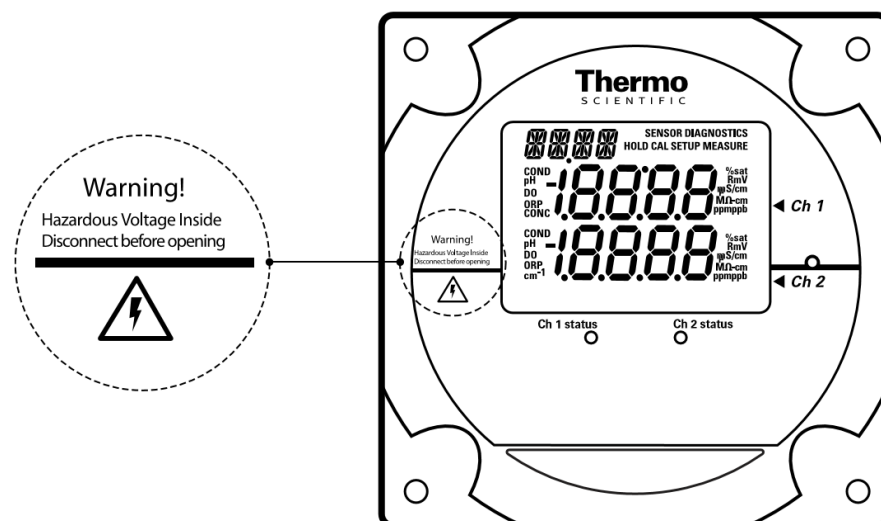
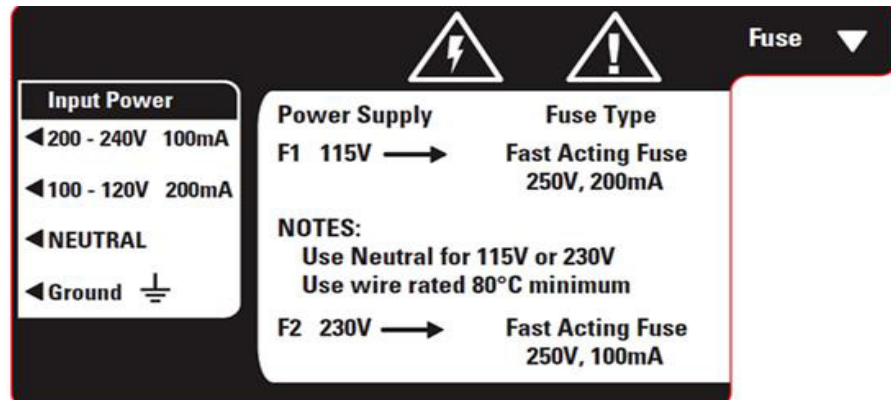

Figure 4: Faceplate

- Power supply – Refer to Figure 5.

Figure 5: Power Supply



Note: Replace the fuse only with a fuse of same rating.

Wiring the Analyzer



WARNING: Read and observe the following requirements. If you install the wrong fuse for your system, you could damage the analyzer. Make sure that you select the correct fuse rating and discard the additional fuses supplied in the fuse kit.

Required Tools

- Options kit – includes fuses, cable glands, conduit fitting and green screw terminal.
- Phillips head screwdriver.
- 2 mm blade flat-head screwdriver.

Figure 6: Electronics Enclosure with Cable Glands

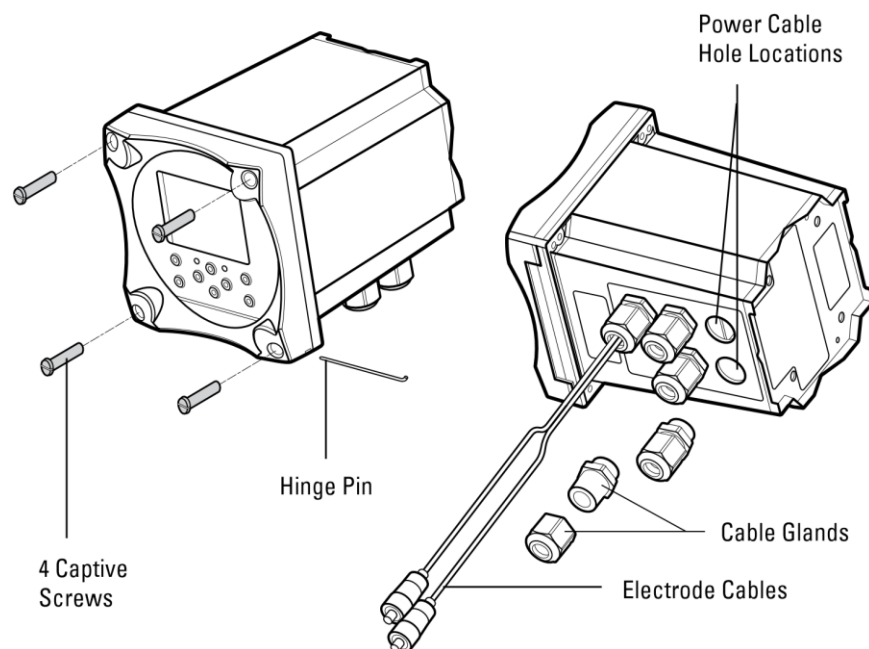

1. Open the faceplate – loosen the four screws using a Phillips head screwdriver. The electronics faceplate will open via the hinge pin connection.
2. Remove one or two of the two unused cable glands as required for wiring power cable or auxiliary connections. Power cable optional hole locations are shown in Figure 6.
3. Select and install the appropriate size cable gland or conduit fitting as required.
4. Feed the power cable through the conduit or cable glands as required.

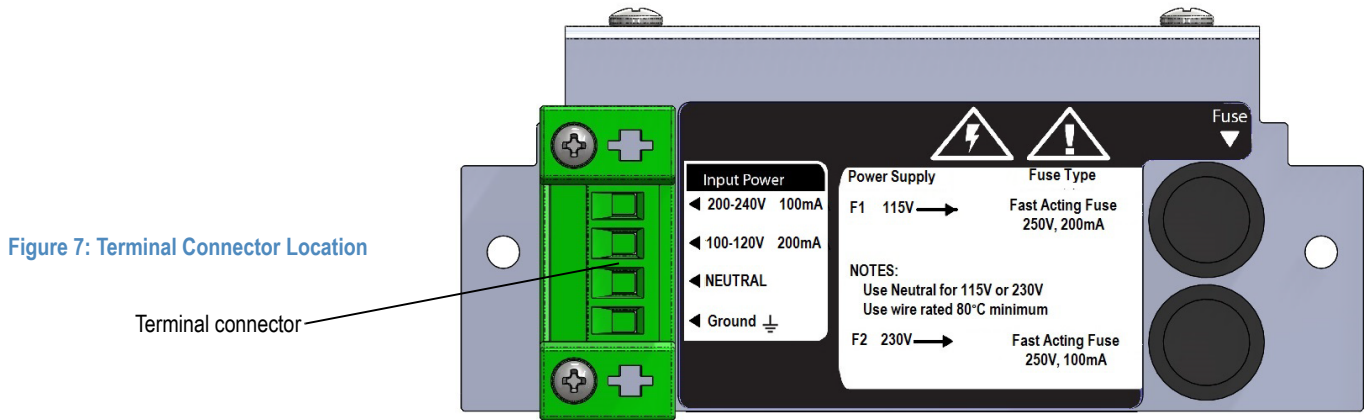

5. Wire the power cable to the green screw terminal connector from the options kit. Select correct terminal for hot conductor depending on line voltage, insert ground wire into the correct terminal and connect the other cable to the neutral terminal. Refer to Figure 7 for terminal connector location.
6. Plug the terminal connector into the power supply. Refer to Figure 5.
7. The universal power supply uses both fuses in the fuse kit. Install by inserting the fuse in the fuse holder and secure it using the twist and lock method. The fuses are clearly labeled with the appropriate voltages for your system. Refer to Figure 5 and Figure 7 for the correct fuse holder positions. Refer to the table below for fuses required.

AC Voltage	Fuse Rating
115V	200mA, 250V, Fast Acting
230V	100mA, 250V Fast Acting

Terminal Assignments

Terminal Layout		Terminal Layout		Terminal Layout		Terminal Layout	
1	mA1 output	9	Relay 1	26	Sensing electrode	28	Do not connect
2	GND common ground	10	Relay 1	27	Do not connect	29	Do not connect
3	mA2 output	11	Relay 2			30	Preamp power
4	Air pump (ISE only)	12	Relay 2			31	Preamp ground
5	Air pump (ISE only)	13	Relay 3			32	Shield
6	Shield ground for conductivity	14	Relay 3			33	Shield
7	Do not connect	15	Do not connect			34	Jumper to pin 26 when using preamp
8	Do not connect	16	Temperature ground				
		17	Temperature drive				
		18	Temperature sense				
		19	Solution ground				
		20	Conductivity drive +				
		21	Conductivity sense +				
		22	Conductivity sense -				
		23	Conductivity drive -				
		24	Reference electrode				
		25	Jumper to pin 24 when using preamp				

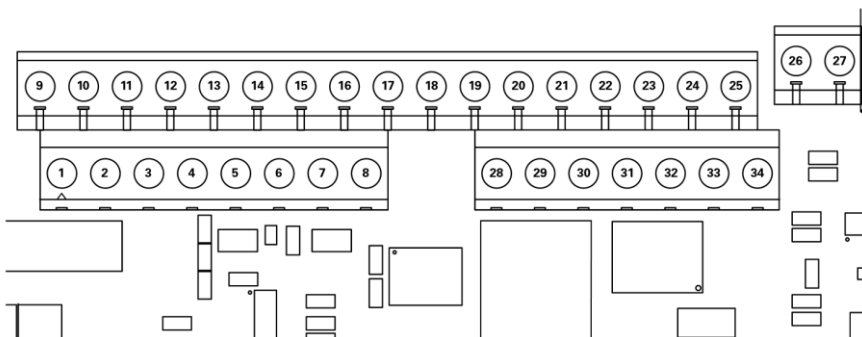

Figure 8: Terminal Assignments

Electrode Wiring Assignments

Chloride Electrode		
26	Sensing electrode	Connect clear wire
33	Shield	Connect black wire

Reference Electrode		
24	Reference electrode	Connect clear wire
32	Shield	Connect black wire

2100TP Temperature Probe		
16	Temperature ground / thermistor	Connect white wire
17	Temperature drive / thermistor	Connect green wire
19	Solution ground	Connect red wire

2001TM Temperature Probe		
16	Temperature ground / thermistor	Connect white wire
17	Temperature drive / thermistor	Connect green wire, jumper 17 and 18
18	Temperature sense	Jumper to 17
19	Solution ground	Connect red wire

2001SC pH Electrode		
24	Reference electrode	Connect black wire
26	Sensing electrode	Connect clear wire

110250 ORP Electrode		
19	Solution ground	Connect black wire
24	Reference electrode	Connect purple wire
26	Sensing electrode	Connect coax center wire

2002CC and 2002SS Conductivity Probes		
6	Shield ground for conductivity	Connect clear wire
16	Temperature ground / thermistor	Connect white wire
17	Temperature drive / thermistor	Connect black wire
20	Conductivity drive +	Connect orange wire
21	Conductivity sense +	Connect red wire
22	Conductivity sense -	Connect green wire
23	Conductivity drive -	Connect blue wire

Installation of Reagent and Diffusion Tubing



WARNING: The reagent is hazardous. Use protective glasses and gloves. Refer to the bottle label for precautions and work in fume hood or a well-ventilated area. Avoid contact with skin or clothes. In case of skin contact, flush skin immediately with water to prevent burns.

1. Support the bottom of the reagent bottle and release the holding clamp with one hand. Turn the thumbscrew counterclockwise to release the reagent bottle. Unscrew the white bottle cap and gray tubing connector assembly. The bottle that is supplied with the analyzer can be used as a spare.
2. Take a new bottle of the reagent (Cat. No. 182011) to a well ventilated area, such as a laboratory fume hood. Unscrew and remove the white cap on the bottle.
3. Connect the diffusion tubing (in kit 182011) to the tubing connector assembly. Place the tubing assembly and cap into the bottle.
4. Replace the gray cap and screw the white cap on tightly.
5. Insert the four nipples on the top of the reagent bottle into the fluid connector block.
6. Support the bottom of the reagent bottle with one hand and tighten the thumbscrew clockwise.
7. Clamp the bottle to the fluidics panel to secure it.

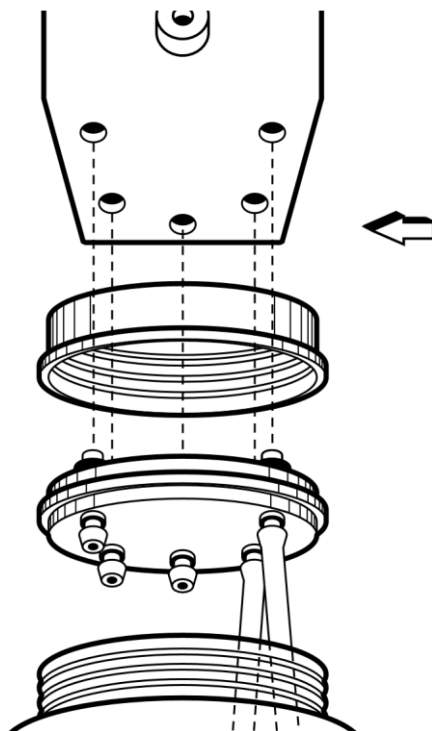

Figure 9: Reagent Bottle Assembly

Cooler Connection Instructions

1. Open the bag which contains the tubing components. The bag should contain 10 feet of 1/4" plastic tubing, 5 feet of foam tubing insulation, and two 1/4-3/8 union compression fittings.
2. Cut the plastic tubing into two five-foot lengths. Ensure that the cut is straight, and the tubing end is smooth and undamaged.
3. Remove the nut from the unused compression fitting on the back of the fluids block, and slide it over the end of one of the pieces of plastic tubing. Leave about one inch of tubing protruding from the end of the nut, as shown in Figure 8.
4. Insert the tubing into the hole of the compression fitting until it cannot be pushed any further. Then, slide the nut back over the threads of the fitting and tighten while holding the tubing in place.
5. Remove the nut from the unused compression fitting on the back of the flow cell, and slide it over the end of the other piece of plastic tubing. Leave about one inch of tubing protruding from the end of the nut, as shown in Figure 8.
6. Insert the tubing into the hole of the compression fitting until it cannot be pushed any further. Then, slide the nut back over the threads of the fitting and tighten while holding the tubing in place.
7. Remove the larger nut from one of the union compression fitting, and slide it over the end of one of the rigid tubing outlets on the lid of the refrigerated bath. Leave about one inch of tubing protruding from the end of the nut, as shown in Figure 8.
8. Slide the compression fitting over the rigid tubing until it cannot be pushed any further. Then, slide the nut back over the threads of the fitting and tighten while holding the compression fitting in place.
9. Repeat steps 7 and 8 for the other compression fitting.
10. Slide the free end of the plastic tubing connected to the flowcell into the insulation tubing. Push the insulation tubing down the length of the plastic tubing until it cannot be pushed any further.
11. Push the free end of the foam insulation back, exposing about two inches of plastic tubing. Remove the smaller nut from one of the union compression fitting on the lid, and slide it over the end of the exposed plastic tubing. Leave about one inch of tubing protruding from the end of the nut, as shown in Figure 8.
12. Insert the tubing into the hole of the compression fitting on the lid until it cannot be pushed any further. Then, slide the nut back over the threads of the fitting and tighten while holding the tubing in place.
13. Remove the smaller nut from the unused compression fitting on the lid, and slide it over the free end of the other length of plastic tubing. Leave about one inch of tubing protruding from the end of the nut, as shown in Figure 8.
14. Insert the tubing into the hole of the compression fitting on the lid until it cannot be pushed any further. Then, slide the nut back over the threads of the fitting and tighten while holding the tubing in place.

Installation of New Electrode Cables

1. Unpack the electrode cables.
2. Feed the tinned wires through the cable gland assemblies with the holes (2 or 1).
3. Follow the terminal assignments shown in Figure 8 for the proper electrode cable wiring location.

Ferrite Installation

1. Open the ferrite using a flat tip screwdriver to lift the latch of the ferrite.
2. Feed the cable wires through the center of the ferrite and then loop the cable wires around the ferrite core and through the center of the ferrite again.
3. Place the ferrite at the bottom of the analyzer chassis, near its edge. Adjust the ferrite location on the cable so the ferrite is near the top of the cable.



Figure 10: Ferrite Installation

Installation of a New Chloride Electrode

The Thermo Scientific Orion chloride electrode (Cat. No. 100025) must be used in conjunction with the Thermo Scientific Orion reference electrode (Cat. No. 100057).

1. Unpack the chloride electrode (Cat. No. 100025) and carefully remove the protective cap. Save the cap for future storage of the electrode. Use the electrode polishing strip (Cat. No. 948201) to gently polish the sensing surface of the chloride electrode for about 30 seconds.
2. Insert the chloride electrode into its port in the flow cell cap. Refer to Figure 11 for the location.
3. Plug the electrode cable marked “Sensing” into the top of the electrode. Be sure to push back the black cap to verify a secure connection between the male and female pin connection prior to tightening.
4. Tighten the screw cap connection to the cable.

Note: Do not twist the cable while tightening the connection. Twisting may cause damage requiring premature replacement of the cable.
5. Wait at least one hour before calibrating the analyzer.

Figure 11: Flow Cell Cap

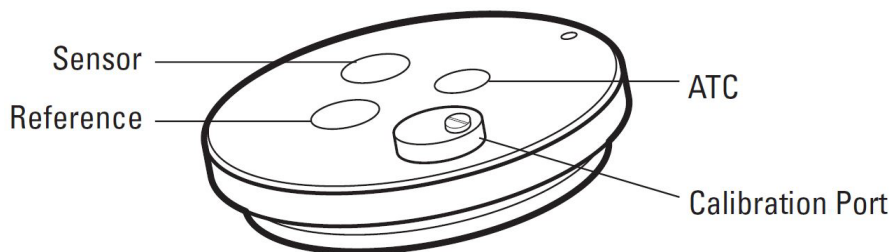

Installation of the ATC Probe

The automatic temperature compensation (ATC) probe (Cat. No. 2100TP) is already connected to the correct terminal for temperature upon delivery.

1. Insert ATC probe into the smaller back hole located behind and in-between the larger holes.

Installation of a New Reference Electrode

Danger: Turn off the air pump prior to removing the reference electrode filling solution bottle. If the air pump is left on, it will spatter filling solution as the bottle is removed.

1. Unpack the reference electrode (Cat. No. 100057) and its instruction sheet from the shipping box.
2. Carefully remove the protective caps from the bottom and sidearm of the reference electrode. Save the caps for future storage of the electrode.
3. Shake out as much of the filling solution as possible through the sidearm. Drain the fill solution through the sidearm or use a pipet or syringe.
4. While passing the 1/8 inch tubing into electrode sidearm, slide the 1/4 inch tubing over the sidearm. The outside tubing should extend 3/8 to 1/2 inches over sidearm. Refer to Figure 12.

Figure 12: Reference Electrode with Filling Solution

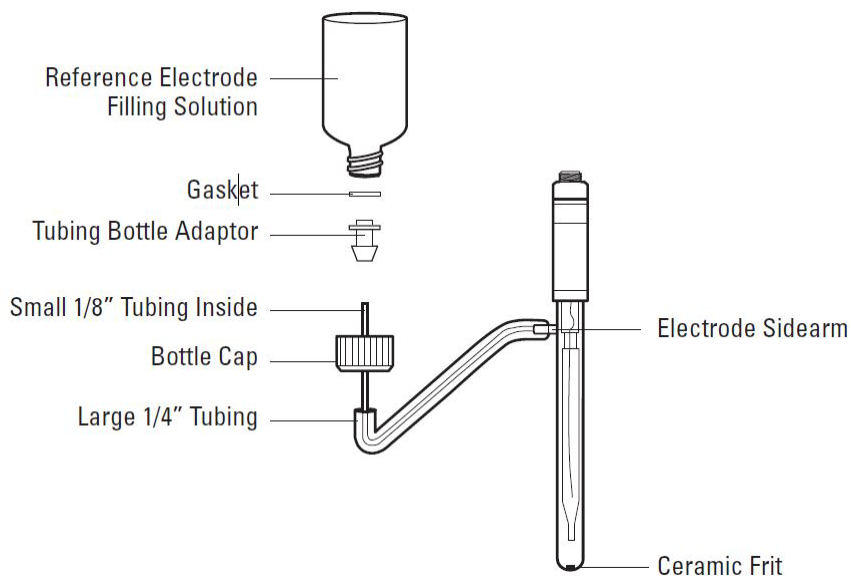

5. Remove the cap and fluid seal from reference electrode fill solution bottle (Cat. No. 100057F4). Hold the bottle in an upright position. Check that the rubber gasket is properly aligned, and then connect the cap end of the tubing assembly to the bottle. The 1/8 inch tubing should extend into the bottle.
6. Hold the reservoir bottle above the electrode with the bottle cap end down. The electrode should be horizontal with the sidearm pointing up. Gently shake the electrode to allow any trapped air bubbles to rise into the bottle as the electrode fills with solution.
7. Dry off the ceramic frit on the base of the electrode with a lint-free wipe. Squeeze the bottle for a few seconds. A small amount of filling solution should bead up on the frit surface, indicating good filling solution flow. If no moisture is visible, the electrode is clogged and should be cleaned or replaced.
8. Invert the electrolyte bottle and snap it into the clip. Refer to Figure 13. Mark and date the level of filling solution in the reservoir. The electrolyte solution will begin to flow into the reference electrode.
9. Plug the electrode cable marked "Reference" into the top of the electrode, and tighten the screw cap. Be sure to push back the black cap to verify a secure connection between the male and female pin connection prior to tightening.
10. Tighten the screw cap connection to the cable.

Note: Do not twist the cable while tightening the connection. Twisting may cause damage requiring premature replacement of the cable.
11. Insert the reference electrode into its port in the flow cell cap.

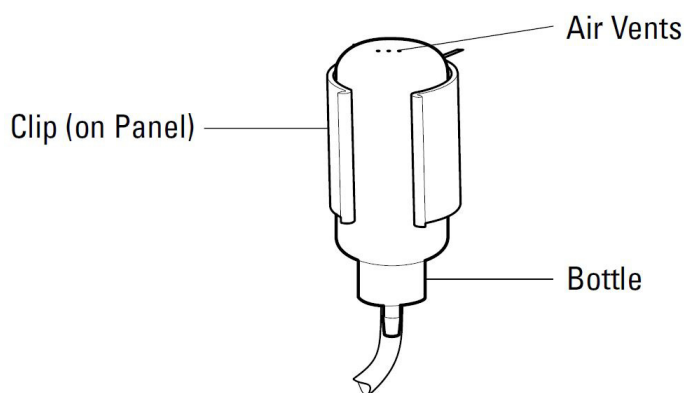

Figure 13: Reference Mounting Clip

3

SECTION 3 Analyzer Operation

Description of Basic Controls

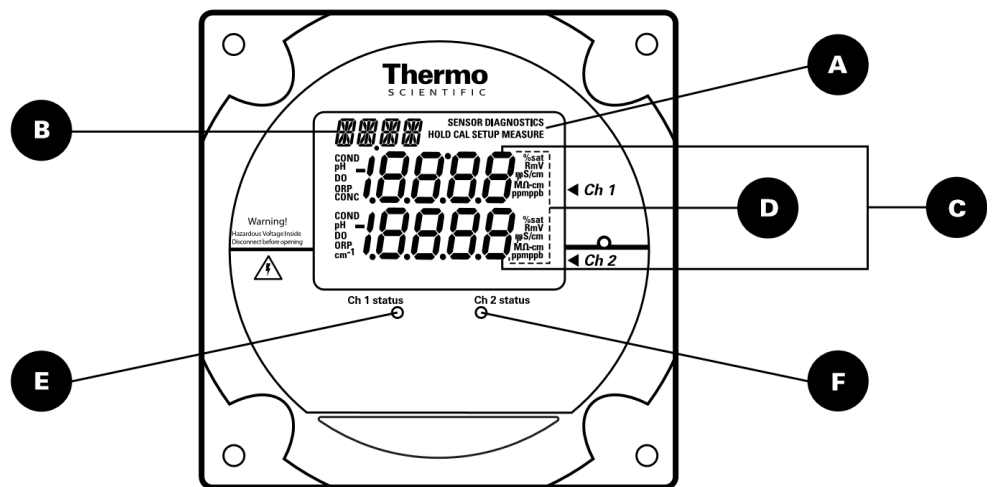



Figure 14: Faceplate

	Parameter	Location on Display	Options	Default
A	Mode Indicator	Top right corner of display	HOLD, CAL, SETUP, MEASURE, DIAGNOSTIC	MEASURE
B	Marquee Display	Top left corner of display	Analyzer provides prompts for operator using the scrolling message	

	Parameter	Location on Display	Options	Default
	Temperature Display		Celsius	In the measure mode, if an ATC probe is connected the default is the actual measured temperature and if no ATC probe is connected the default is 25 °C
C	Main Data Display	Middle line and bottom line of display	ISE board: concentration pH/mV board: pH or mV Conductivity board: conductivity, resistivity, salinity, concentration or TDS	Depends on type of board installed and selected measurement parameter
D	Measurement Units	Left and right side of middle and bottom display lines	ISE board: ppm or ppb, auto-ranging pH/mV board: pH or mV Conductivity board: $\mu\text{S}/\text{cm}$ or mS/cm (conductivity), $\text{M}\Omega\text{-cm}$ (resistivity), SAL1 or SAL2 in the marquee (salinity), PCT1 or PCT2 in the marquee (concentration) and TDS1 or TDS2 in the marquee (TDS)	Depends on type of board installed and selected measurement parameter
E	Channel 1 Status Indicator	Below display screen, to the left of 	Green LED indicates that channel is OK Orange LED indicates a channel warning Red LED indicates a channel failure	At initial installation, the red LED indicates that the electrode or probe needs to be installed and calibrated.
F	Channel 2 Status Indicator	Below display screen, to the right of 	Green LED indicates that channel is OK Orange LED indicates a channel warning Red LED indicates a channel failure	At initial installation, the red LED indicates that the electrode or probe needs to be installed and calibrated.

Description of Keypad Icons

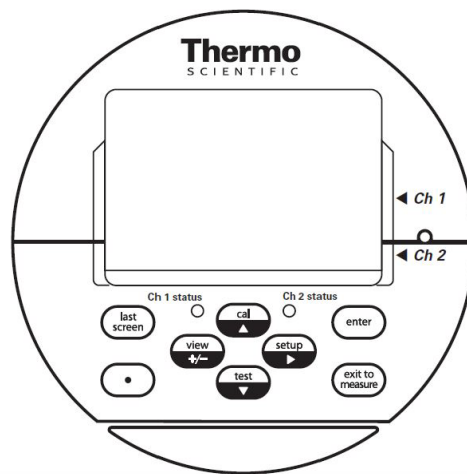









Figure 15: Keypad Icons









Key	Parameter/Mode	Action	Operational Selections
	Enters calibration mode	Calibration mode with operator prompts	Depends on type of board installed
	Scrolls up digit numbers Scrolls up through a list of options in setup and cal modes	Use to edit numeric values Use to select available options	0 through 9 selectable by digit, first digit sometimes selectable 0 through 19





Key	Parameter/Mode	Action	Operational Selections
	Enters setup mode	System setup mode at the last parameter used by the operator	PASS, DATE, TIME, LOG, RSET, DISP, CH1, CH2, MDL, MEAS, HOLD, TCMP, TADJ, ALRM, mA1, mA2, mADJ, TEST, CAL, PH, COND, DYN
	Moves to the next digit	Use to edit values	When moved to final digit, the system will wrap around to first digit
	Enters test mode	Use to advance through sequence of displays DIAGNOSTICS will appear in top right of screen	
	Scroll down digit numbers Scroll down through a list of options in setup and cal modes	Use to edit numeric values Use to select available options	0 through 9 selectable by digit, first digit sometimes selectable 0 through 19
	Enters log view mode	Use to view data in calibration, measure and status logs	
	+/- function	Enters negative/positive sign when editing numbers	
	Enter function	Use to accept value or selection displayed on screen and store value or selection in memory	
	Enter function (in test mode only)	Use in test mode to display additional information for selected menus	
	Exit to measure function	Use to exit setup or cal modes and enter the measure mode	Analyzer automatically enters measure mode when first turned on and after calibration
	Last screen function	Use in setup and test modes to return to the previous screen or menu	
	Decimal point function	Use to set the decimal point position in certain menus with numbers that require a decimal point	

Use of the Setup Mode



Before the first sample measurements can be taken, the setup mode should be programmed and a successful calibration must be performed by the operator and stored in the memory of the analyzer.



Navigating Tips for the Setup Mode

- Press  to enter the setup mode.
- SETUP appears in the mode indicator screen.
- HOLD is displayed while in the setup mode.
- The analyzer will enter the setup mode at the last menu that was used by the operator.
- Press  and  to loop through the menu options.
- Press  to select the desired menu option and set the menu option parameters.
- Press  and  to:
 - Scroll between On and OFF for the selected menu option.
 - Scroll and set the first digit value to 0 through 19.
 - Scroll and set the remaining digit values to 0 through 9.
- Press  to move to the next digit (scroll right) to set each digit value (4 digits maximum).
- Press  to save the entered parameter for the selected menu option.

- Press  to exit the current screen and return to the previous screen.
- Press  to exit the setup mode and return to the measure mode. If  is pressed,  will not return the operator to the setup mode. The operator must reenter the setup mode by pressing .

Channel Specific Menu Options in the Setup Mode

If a single channel analyzer is in use, all of the menu options are accessible by pressing  /  in the setup mode. The system will loop through the menu options and all of the menu options are in the same level of the setup mode.

If a two channel analyzer is in use, only the general menu options are accessible by pressing  /  in the setup mode. The channel 1 and channel 2 specific menu options must be accessed by selecting the CH1 or CH2 menu options in the setup mode. The channel specific menu options are in the second level in setup mode. If a two channel analyzer is in use, make sure to program both the channel 1 and channel 2 menu options in the setup mode.

Using Password Protection

The default password is 0000 – indicates password protection has not been activated.

System password: Management secured password protection of setup mode and calibration process.

Calibration password: Operator secured password for protection of calibration process only.



If password(s) are activated:

- System prompts operator to enter system password:
- Marquee: ENTER PASSWORD
- Main display top: PASS
- Main display bottom: 0000 (flashing)
- Correct password – Allows operator to enter setup mode for custom programming options.
- Incorrect password – Password incorrect or not entered correctly.
- System password:
 - Marquee: SYSTEM PASS INCORRECT
 - Main display: E035
- Calibration password:
 - Marquee: CAL PASS INCORRECT
 - Main display: E034
- Verify password and re-enter it.

If password(s) are de-activated:

- System enters the setup mode at the last setup menu option used by the operator.
- Marquee: Flashes current menu option
- Main display: SEL SCrn

Setup Mode Overview

The setup mode features programmable menu options. The order of the menu options is dependent on the direction the operator scrolls by pressing  or . The menu options are listed below by pressing .

General Setup Mode Menu Options

The following menu options are displayed in the main setup mode of one and two channel analyzers.

PASS

Set either of two password options:

- System password – Setup settings protected, accessed by authorized operators only
- Calibration password – Calibration menu data is protected, accessed by authorized operators only
- Default password is 0000 – Disables both passwords
- Forgot your password? Contact Technical Support at 1-800-225-1480

DATE

Set the date in US or Europe format:

- Enter month, day and year
- Default date – System will continue to keep date and time due to battery backup, operator must set in accordance to local time zone
- If the battery is removed, the system will show 01/01/2000

TIME

Set the time:

- Enter hour and minutes in 24 hour format
- Default time – System will continue to keep date and time due to battery backup, operator must set in accordance to local time zone
- If the battery is removed, the system will show 00:01

LOG

Set the data logging interval for measure log (calibration and error logs are accessed in the test mode):

- Set the log interval as hour:minute (HH:MM)
- Default log interval is 00:00 – logging disabled
- Minimum log interval is 1 minute; maximum log interval is 99 hours and 59 minutes

RSET

Reset the analyzer to factory defaults for setup parameters:

- Used to troubleshoot the system (a hard reset can be performed if the keypad and software are not responding, refer to Section 6, Resetting the Analyzer)



WARNING: Resetting the analyzer will lose all stored information including relay, logs and calibration settings.

DISP

Set the automatic lighting options for the backlit display:

- AUtO – Brightness will change in response to ambient light source
- On – Backlit display is always on
- OFF – Backlit display is always off
- Default display – AUtO

Channel Specific Setup Mode Menu Options

If a two channel analyzer is in use, the following setup mode menu options are specific to the first channel of the 2117LL analyzer for oxygen scavenger measurements. When a pH/ORP board or conductivity board is installed on the second channel of the 2117LL analyzer, refer to the *Thermo Scientific Orion 2100 Series pH/ORP Analyzer and Conductivity Analyzer User Guide* for detailed instructions on the second channel setup mode menu options.

CH1 or CH2

The operator must select the channel number in the main setup mode (CH1 or CH2) and the menu options that are relative to the measurement capability of that channel will be displayed. If a one channel analyzer is being used, the CH1 and CH2 menus will not be shown.

MEAS

Set the number of significant digits, mV display option and concentration units displayed when in the measure mode:

- Set the number of significant digits displayed measure mode
 - Scroll through 2, 3 or 4 significant digits
 - Default significant digits – 3
- Enable mV values to be displayed on the second line
 - Scroll between On or OFF
 - Default mV setting – OFF
- Set the displayed concentration units
 - Scroll through AUtO (automatically ranges from ppb to ppm), PPb (parts per billion, ppb), or PP (parts per million, ppm)
 - Default displayed concentration units – AUtO

HOLD

Set the time that the system will remain on hold before the actual measurements are displayed after a calibration:

- Once the hold time expires, the system implements any programmed changes to settings in the setup mode
- After a calibration, the hold function allows the operator to rinse the electrodes prior to recording actual measurement values
- Default hold time – 30 minutes

TADJ

Adjust the temperature reading from the ATC probe by ± 5.0 °C:

- Default adjustment – 0.0 degrees C

ALRM

Set up to three alarms – high, low and an error signaling contact:

- Relays 1 and 2 (rLY1, rLY2) are normally open dry contacts used to set high and low alarms for measurement values
 - rLY1 and rLY2 options – OFF, HI, LO
- Relay 3 (rLY3) is normally a closed contact that can be dedicated to errors (will close if power to analyzer is lost), this alarm is influenced by calibration, errors and offline or hold status
 - rLY3 options – OFF, CAL, HOLD, Err
- Default setting for all alarms – OFF

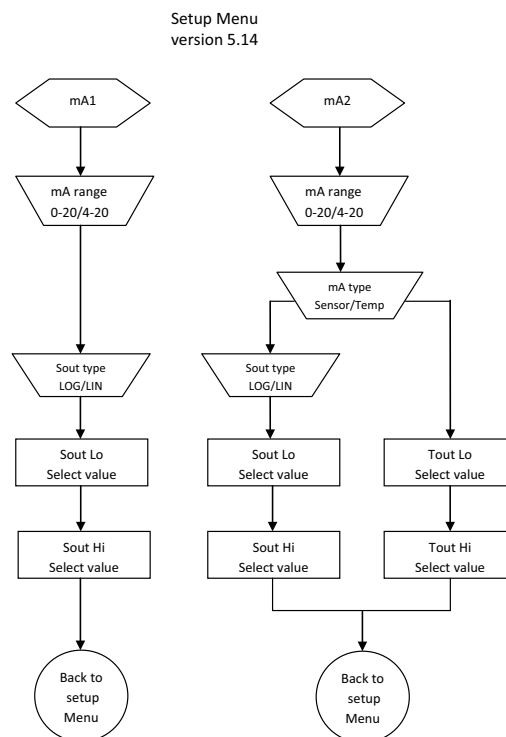

mA1

Set the mA1 analog current output:

- Scroll between 4-20 mA or 0-20 mA current signals
 - The outputs share a common return, but are isolated from the main circuitry of the analyzer
 - Default output current: 4-20 mA
- Scroll between logarithmic (LOg) and linear (LIn) scale.
- Set the low and high limits for the sensor output (SOUt)
 - Default – 1.0 ppb (low) and 100 ppb (high)

mA2

Set the mA2 analog current output:

- Scroll between 4-20 mA or 0-20 mA current signals
 - The outputs share a common return, but are isolated from the main circuitry of the analyzer
 - Default output current: 4-20 mA
- Select Sensor or Temperature for this output (SEnS and tEnP)
If Sense -
- Scroll between logarithmic (LOg) and linear (LIn) scale for SOUt
- Set the low and high limits for the sensor output (SOUt)
 - Default – 1.0 ppb (low) and 100 ppb (high)
- If Temp -
- Set the low and high limits for the temperature output (tOUt)
 - Default – 5.0 °C (low) and 45.0 °C (high)

mADJ

Set the mA offset adjustment value for mA1 and mA2 outputs:

- Select OUT1 or OUT2 output
- Scroll the numeric offset value and positive or negative offset value
- Default mA offset – 00.0 mA

TEST

Test relays and analog output lines (DIAGNOSTICS will appear in the mode indicator):

- Method to activate/deactivate relays and outputs to be tested
- Verify the accuracy of the analog outputs when used with an external loop calibrator
- Provides the values and settings for the mA output and relays
- mA output
 - 4-20
 - The low and high values represented by mA1 and mA2
- Relay status
 - Set RLY1, RLY2 and RLY3 status to OFF or On

CAL



Set calibration frequency in hours:



- High limit is 19999 hours
- Low limit is 00000 hours
- Default setting – 720 hours







DYN









Set values for customized 3-Point Calibration using dynamic injection (DYN) to introduce standards.













- Programmable for the sample flow rate (mL/min), standard chloride concentration used in the syringe (ppm), background concentration (ppb), pump settings for the first and second introductions of the standard, Std 1 and Std2, including percent flow and pump range.
 - Default sample flow rate: 40 mL/min
 - Default background concentration: 0 ppb
 - Default standard concentration: 100 ppm
 - Default pump percent for Std1: 10.1 (%)
 - Default pump range for Std1: 100 (1/100)
 - Default pump percent for Std2: 10.2 (%)
 - Default pump range for Std1: 10 (1/10)









Default	Operator Action	Scrolling Marquee	Main Display	Notes
	SETUP (One Channel Analyzer)			
	Press  to enter setup mode <ul style="list-style-type: none"> • SETUP appears as the mode indicator in the mode window • HOLD is displayed while in the setup mode • The system will enter the setup mode at the last saved menu option 	PASS DATE TIME LOG RSET DISP MEAS HOLD TADJ ALRM mA1 mA2 mADJ TEST CAL DYN	SEL SCrn	The displayed menu options depend on the measurement capability of the analyzer.
	Press  to loop through the menu options			
	Press  to select the desired menu option and enter the submenu to customize setup parameters			









Default	Operator Action	Scrolling Marquee	Main Display	Notes
	SETUP (Two Channel Analyzer)			
	Press  to enter setup mode <ul style="list-style-type: none"> • SETUP appears as the mode indicator in the mode window • HOLD is displayed while in the setup mode • The system will enter the setup mode at the last saved menu option 	PASS DATE TIME LOG RSET DISP CH1 MEAS HOLD TADJ ALRM mA1 mA2 mADJ TEST CAL DYN CH2 MDL HOLD TCMP TADJ ALRM mA1 mA2 mADJ TEST CAL PH	SEL SCrn SEL SCrn SEL SCrn SEL SCrn SEL SCrn SEL SCrn SEL SCrn SEL CH1 SEL CH1 SEL CH1 SEL CH1 SEL CH1 SEL CH1 SEL CH1 SEL CH1 SEL CH1 SEL CH1 SEL CH1 SEL SCrn SEL CH2 SEL CH2 SEL CH2 SEL CH2 SEL CH2 SEL CH2 SEL CH2 SEL CH2 SEL CH2 SEL CH2 SEL CH2	The list of menu options shown for CH2 are examples only. The displayed menu options for CH2 depend on the measurement capability of the channel. If only one board is installed in the analyzer, CH1 and CH2 will not be shown in the scrolling marquee and all of the menu options will be listed in the main setup mode.
	Press  to loop through the menu options			
	Press  to select the desired menu option and enter the submenu to customize setup parameters			

Default	Operator Action	Scrolling Marquee	Main Display	Notes
	PASS	PASS (flashing)	SEL SCrn	
	Press  to set new passwords			
0 0 0 0		SET-UP NEW SYSTEM PASSWORD	PASS # # # # (first digit flashing)	
	Press  /  to set the first digit Press  to move to the next digit Press  /  to set the values of the remaining digits and press  to move through the remaining digits	SET-UP NEW SYSTEM PASSWORD	PASS # # # # (change flashing digit)	Do not scroll first digit above 9

Default	Operator Action	Scrolling Marquee	Main Display	Notes
	Press  to accept the system password and advance to the next screen to set the calibration password			
0 0 0 0		SET-UP NEW CALIBRATION PASSWORD	PASS # # # # (first digit flashing)	
	Press  /  to set the first digit Press  to move to the next digit Press  /  to set the values of the remaining digits and press  to move through the remaining digits	SET-UP NEW CALIBRATION PASSWORD	PASS # # # # (change flashing digit)	Do not scroll first digit above 9
	Press  to accept the calibration password and return to the main setup mode			
		PASS (flashing)	SEL SCrM	
	Press  to scroll to the next menu			







Default	Operator Action	Scrolling Marquee	Main Display	Notes
	DATE	DATE (flashing)	SEL SCrM	
	Press  to set the date			
US		SET USA OR EUROPEAN	US (flashing)	
	Press  /  to scroll between US and EUrO	SET USA OR EUROPEAN	US or EUrO (flashing)	
	Press  to accept the setting and advance to the next screen			
01/01/2000		ENTER DATE MM/DD/YYYY (US) or ENTER DATE DD/MM/YYYY (EUrO)	# # . # # (Month . Day) 2 0 # # (Year) or # # . # # (Day . Month) 2 0 # # (Year) (first digit flashing)	
	Press  /  to set the first digit Press  to move to the next digit Press  /  to set the values of the remaining digits and press  to move through the remaining digits	ENTER DATE MM/DD/YYYY (US) or ENTER DATE DD/MM/YYYY (EUrO)	# # . # # (Month . Day) 2 0 # # (Year) or # # . # # (Day . Month) 2 0 # # (Year) (change flashing digit)	
	Press  to accept the date setting and return to the main setup mode			
		DATE (flashing)	SEL SCrM	
	Press  to scroll to the next menu			

Default	Operator Action	Scrolling Marquee	Main Display	Notes
	TIME	TIME (flashing)	SEL SCrN	
	Press  to set the time			
00:01		ENTER 24HR TIME HOUR/MINUTE	## : ## (hour : minute) (first digit flashing)	
	Press  /  to set the first digit Press  to move to the next digit Press  /  to set the values of the remaining digits and press  to move through the remaining digits	ENTER 24HR TIME HOUR/MINUTE	## : ## (hour : minute) (change flashing digit)	Set in 24 hour time format
	Press  to accept the time setting and return to the main setup mode			
		TIME (flashing)	SEL SCrN	
	Press  to scroll to the next menu			

Default	Operator Action	Scrolling Marquee	Main Display	Notes
	LOG	LOG (flashing)	SEL SCrN	
	Press  to set the log interval			
00:00		SET LOG TIME IN HOUR/MINUTE	## : ## (hour : minute) LOg (first digit flashing)	
	Press  /  to set the first digit Press  to move to the next digit Press  /  to set the values of the remaining digits and press  to move through the remaining digits	SET LOG TIME IN HOUR/MINUTE	## : ## (hour : minute) LOg (change flashing digit)	To disable the log enter 0000 for the log interval The minimum log interval is 1 minute and the maximum log interval is 99 hours and 59 minutes
	Press  to accept the log setting and return to the main setup mode			
		LOG (flashing)	SEL SCrN	
	Press  to scroll to the next menu			







WARNING: The reset command will erase all operator settings, logs and calibration data. The analyzer will need to be set up and calibrated again before it can resume operation.





Default	Operator Action	Scrolling Marquee	Main Display	Notes
	RSET	RSET (flashing)	SEL SCm	
	Press  to reset the analyzer			
		PUSH TEST VIEW ENTER TO RESET	rSEt?	
	To Reset the Analyzer:			
	Press  Press  Press  When the reset is complete, the system will return to the measure mode. The operator will need to re-enter the setup mode to continue programming the setup parameters. Press  to return to the setup mode.	PUSH TEST VIEW ENTER TO RESET	rSEt?	This command resets all previously set parameters to factory default values. Use this command only to set the analyzer to original factory setup values.
	To Abort the Reset:			
	Press  to return to the main setup mode	PRESS TEST VIEW ENTER TO RESET	rSEt?	
		RSET (flashing)	SEL SCm	
	Press  to scroll to the next menu			



















WARNING: Resetting the analyzer will erase all stored information including relay, logs and calibration settings.























Default	Operator Action	Scrolling Marquee	Main Display	Notes
	DISP	DISP (flashing)	SEL SCm	
	Press  to set the lighting option for the backlit display			
AUTO		BACK LITE	LiTE AUtO (flashing)	
	Press  /  to scroll through AUtO, OFF and On settings	BACK LITE	LiTE AUtO, OFF or On (flashing)	
	Press  to accept the display setting and return to the main setup mode			
		DISP (flashing)	SEL SCm	
	Press  to scroll to the next menu			











Note: The following menu options are for analyzers with two modules installed only. If two channels are used, select the channel number in the main setup mode (CH1 or CH2) and additional menu options will be displayed.





Default	Operator Action	Scrolling Marquee	Main Display	Notes
	CH1	CH1 (flashing)	SEL SCrn	CH1 will not be shown in scrolling marquee if only one board is installed
	Press  to set the channel 1 specific menus in the setup mode			
	Press  to loop through the channel specific menu options	MDL (flashing)	SEL CH1	
	Press  to select a menu option and customize the parameter (refer to the menu option displays that are shown on the following pages for detailed instructions)			
		CH1 (flashing)	SEL SCrn	
	Press  to scroll to the next menu			

























Default	Operator Action	Scrolling Marquee	Main Display	Notes
	CH2	CH2 (flashing)	SEL SCrn	CH2 will not be shown in scrolling marquee if only one board is installed
	Press  to set the channel 2 specific menus in the setup mode			
	Press  to loop through the channel specific menu options	MDL (flashing)	SEL CH2	
	Press  to select a menu option and customize the parameter (when a pH/ORP or conductivity board is installed on channel 2, refer to the Thermo Scientific Orion 2100 Series pH/ORP Analyzer and Conductivity Analyzer User Guide for detailed instructions on the menu option displays)			
		CH2 (flashing)	SEL SCrn	
	Press  to scroll to the next menu			

Default	Operator Action	Scrolling Marquee	Main Display	Notes
	MEAS	MEAS (flashing)	SEL SCrn	SEL CH1 or SEL CH2 on main display of two channel analyzer
	Press  to set measure parameters			
3		SET NUMBER OF SIGNIFICANT DIGITS	Slg 3 (flashing)	
	Press  /  to scroll through 2, 3 and 4	SET NUMBER OF SIGNIFICANT DIGITS	Slg 2, 3 or 4 (flashing)	
	Press  to accept the setting and advance to the next screen			
OFF		SHOW MV ON SINGLE CHANNEL DISPLAY	OFF (flashing)	
	Press  /  to scroll between OFF and On	SHOW MV ON SINGLE CHANNEL DISPLAY	OFF or On (flashing)	
	Press  to accept the setting and advance to the next screen			
AUTO		SELECT ISE UNIT	Unit AUTO (flashing)	
	Press  /  to scroll through AUTO, PPb and PP	SELECT ISE UNIT	Unit AUTO, PPb or PP (flashing)	PP is used as an abbreviation for ppm
	Press  to accept the setting and return to the main setup mode			
		CH1 or CH2 (flashing)	SEL SCrn	Displayed for two channel analyzer
	Press  to return to the channel specific menu options in the setup mode			Action required for two channel analyzer
		MEAS (flashing)	SEL SCrn	SEL CH1 or SEL CH2 on main display of two channel analyzer
	Press  to scroll to the next menu			

























Default	Operator Action	Scrolling Marquee	Main Display	Notes
	HOLD	HOLD (flashing)	SEL SCrM	SEL CH1 or SEL CH2 on main display of two channel analyzer
	Press  to set the hold time			
00:30		ENTER HOLD TIME HOUR/MINUTE	## : ## (first digit flashing)	
	Press  /  to set the first digit Press  to move to the next digit Press  /  to set the values of the remaining digits and press  to move through the remaining digits	ENTER HOLD TIME HOUR/MINUTE	## : ## (change flashing digit)	
	Press  to accept the setting and advance to the next screen			
LASt		ENTER HOLD STATE LAST OR USER VALUE	LASt (flashing)	
	Press  /  to scroll between LASt and USEr	ENTER HOLD STATE LAST OR USER VALUE	LASt or USEr (flashing)	
	Press  to accept the setting and advance to the next screen			
21.0		ENTER FIXED USER VALUE IN mA	## . # (first digit flashing)	Displayed if USEr was selected in previous screen
	Press  /  to set the first digit Press  to move to the next digit Press  /  to set the values of the remaining digits and press  to move through the remaining digits	ENTER FIXED USER VALUE IN mA	## . # (change flashing digit)	Action required if USEr was selected in previous screen
	Press  to accept the setting and advance to the next screen			Action required if USEr was selected in previous screen
OFF		HOLD TO 22mA WHEN ERROR	OFF (flashing)	
	Press  /  to scroll between OFF and On	HOLD TO 22mA WHEN ERROR	OFF or On (flashing)	
	Press  to accept the setting and return to the main setup mode			
		CH1 or CH2 (flashing)	SEL SCrM	Displayed for two channel analyzer
	Press  to return to the channel specific menu options in the setup mode			Action required for two channel analyzer
		HOLD (flashing)	SEL SCrM	SEL CH1 or SEL CH2 on main display of two channel analyzer
	Press  to scroll to the next menu			

Default	Operator Action	Scrolling Marquee	Main Display	Notes
	TADJ	TADJ (flashing)	SEL SCrn	SEL CH1 or SEL CH2 on main display of two channel analyzer
	Press  to set the temperature adjustment value			
0.0 C		TEMPERATURE ADJUSTMENT	AdJ # . # c (first digit flashing)	
	Press  /  to set the first digit Press  to move to the next digit Press  /  to set the value of the next digit	TEMPERATURE ADJUSTMENT	AdJ # . # c (change flashing digit)	The maximum temperature adjustment is ± 5.0 °C
	Press  to set a positive or negative temperature value	TEMPERATURE ADJUSTMENT	AdJ - # . # c	
	Press  to accept the setting and return to the main setup mode			
		CH1 or CH2 (flashing)	SEL SCrn	Displayed for two channel analyzer
	Press  to return to the channel specific menu options in the setup mode			Action required for two channel analyzer
		TADJ (flashing)	SEL SCrn	SEL CH1 or SEL CH2 on main display of two channel analyzer
	Press  to scroll to the next menu			



























Default	Operator Action	Scrolling Marquee	Main Display	Notes
	ALRM	ALRM (flashing)	SEL SCrn	SEL CH1 or SEL CH2 on main display of two channel analyzer
	Press  to set the alarms			
OFF		SELECT ALARM 1 HIGH LOW OR OFF	rLY1 OFF (flashing)	
	Press  /  to scroll through OFF, HI and LO	SELECT ALARM 1 HIGH LOW OR OFF	rLY1 OFF, HI or LO (flashing)	
	Press  to accept the setting and advance to the next screen			





















Default	Operator Action	Scrolling Marquee	Main Display	Notes
100 ppb	Set the HI or LO value for rLY1: Press  to move the decimal point Press  /  to set the first digit Press  to move to the next digit Press  /  to set the values of the remaining digits and press  to move through the remaining digits	ENTER VALUE	rLY1 ##.## (change flashing digit)	Displayed if HI or LO was selected for rLY1 in previous screen
	Press  to accept the setting and advance to the next screen			Action required if HI or LO was selected for rLY1 in previous screen
OFF		SELECT ALARM 2 HIGH LOW OR OFF	rLY2 OFF (flashing)	
	Press  /  to scroll through OFF, HI and LO	SELECT ALARM 2 HIGH LOW OR OFF	rLY2 OFF, HI or LO (flashing)	
	Press  to accept the setting and advance to the next screen			
1 ppm	Set the HI or LO value for rLY1: Press  to move the decimal point Press  /  to set the first digit Press  to move to the next digit Press  /  to set the values of the remaining digits and press  to move through the remaining digits	ENTER VALUE	rLY2 ##.## (change flashing digit)	Displayed if HI or LO was selected for rLY2 in previous screen
	Press  to accept the setting and advance to the next screen			Action required if HI or LO was selected for rLY2 in previous screen
OFF		SELECT CALIBRATION HOLD ERROR OR OFF	rLY3 OFF (flashing)	
	Press  /  to scroll through OFF, CAL, HOLD and Err	SELECT CALIBRATION HOLD ERROR OR OFF	rLY3 OFF, CAL, HOLd or Err (flashing)	
	Press  to accept the setting and return to the main setup mode			
		CH1 or CH2 (flashing)	SEL SCrm	Displayed for two channel analyzer
	Press  to return to the channel specific menu options in the setup mode			Action required for two channel analyzer
		ALRM (flashing)	SEL SCrm	SEL CH1 or SEL CH2 on main display of two channel analyzer
	Press  to scroll to the next menu			

















Configuring the analog output mA1



Default	Operator Action	Scrolling Marquee	Main Display	Notes
	mA1	mA1 (flashing)	SEL SCrn	SEL CH1 or SEL CH2 on main display of two channel analyzer
	Press  to set the analog output 1			
4-20	Press  /  to scroll between 4-20 and 0-20	SELECT 0-20 OR 4-20	4-20 or 0-20 (flashing)	
	Press  to accept the setting and advance to the next screen			
LOg	Press  /  to scroll between LOg and LIn	SELECT LOG OR LINEAR OUTPUT	SOUT LOg or LIn (flashing)	
	Press  to accept the setting and advance to the next screen			
1 ppb		mA SENSOR OUTPUT LOW VALUE	LO ###.# (first digit flashing)	
	Press  to move the decimal point Press  /  to set the first digit Press  to move to the next digit Press  /  to set the values of the remaining digits and press  to move through the remaining digits	mA SENSOR OUTPUT LOW VALUE	LO ###.# (change flashing digit)	
	Press  to accept the setting and advance to the next screen			
100 ppb		mA SENSOR OUTPUT HIGH VALUE	HI ###.# (first digit flashing)	
	Press  to move the decimal point Press  /  to set the first digit Press  to move to the next digit Press  /  to set the values of the remaining digits and press  to move through the remaining digits	mA SENSOR OUTPUT HIGH VALUE	HI ###.# (change flashing digit)	
	Press  to accept the setting and advance to the next screen			
		CH1 or CH2 (flashing)	SEL SCrn	Displayed for two channel analyzer
	Press  to return to the channel specific menu options in the setup mode			Action required for two channel analyzer
		mA1 (flashing)	SEL SCrn	SEL CH1 or SEL CH2 on main display of two channel analyzer
	Press  to scroll to the next menu			











Configuring the analog output mA2

















Default	Operator Action	Scrolling Marquee	Main Display	Notes
	mA2	mA2 (flashing)	SEL SCrn	SEL CH1 or SEL CH2 on main display of two channel analyzer
	Press  to set the analog output 2			
4-20	Press  /  to scroll between 4-20 and 0-20	SELECT 0-20 OR 4-20	4-20 or 0-20 (flashing)	
	Press  to accept the setting and advance to the next screen			
		AOUT 2 SENSOR OR TEMPERATURE	SEnS (flashing)	
	If choosing Sensor:			
	Press  /  to scroll between SEnS or tEnP and select SEnS	AOUT 2 SENSOR OR TEMPERATURE	SEnS (flashing)	
	Press  to accept the setting and advance to the next screen			
LOg	Press  /  to scroll between LOg and Lln	SELECT LOG OR LINEAR OUTPUT	LOg or Lln (flashing)	
	Press  to accept the setting and advance to the next screen			
1 ppb		mA SENSOR OUTPUT LOW VALUE	LO ###.# (first digit flashing)	
	Press  to move the decimal point Press  /  to set the first digit Press  to move to the next digit Press  /  to set the values of the remaining digits and press  to move through the remaining digits	mA SENSOR OUTPUT LOW VALUE	LO ###.# (change flashing digit)	
	Press  to accept the setting and advance to the next screen			
100 ppb		mA SENSOR OUTPUT HIGH VALUE	HI ###.# (first digit flashing)	
	Press  to move the decimal point Press  /  to set the first digit Press  to move to the next digit Press  /  to set the values of the remaining digits and press  to move through the remaining digits	mA SENSOR OUTPUT HIGH VALUE	HI ###.# (change flashing digit)	
	Press  to accept the setting and advance to the next screen			

Default	Operator Action	Scrolling Marquee	Main Display	Notes
		CH1 or CH2 (flashing)	SEL SCrn	Displayed for two channel analyzer
	Press  to return to the channel specific menu options in the setup mode			Action required for two channel analyzer
		mA2 (flashing)	SEL SCrn	SEL CH1 or SEL CH2 on main display of two channel analyzer
	Press  to scroll to the next menu			
	If choosing temperature:			
	Press  /  to scroll between SEnS or tEnP and select tEnP	AOUT 2 SENSOR OR TEMPERATURE	tEnP (flashing)	
	Press  to accept the setting and advance to the next screen			
05.0 C		mA TEMP OUTPUT LOW VALUE	LO ##. # c (first digit flashing)	
	Press  /  to set the first digit Press  to move to the next digit Press  /  to set the values of the remaining digits and press  to set a positive or negative temperature value	mA TEMP OUTPUT LOW VALUE	LO ##. # c (change flashing digit)	
	Press  to accept the setting and advance to the next screen			
45.0 C		mA TEMP OUTPUT HIGH VALUE	HI ##. # c (first digit flashing)	
	Press  /  to set the first digit Press  to move to the next digit Press  /  to set the values of the remaining digits and press  to move through the remaining digits	mA TEMP OUTPUT HIGH VALUE	HI ##. # c (change flashing digit)	
	Press  to accept the setting and return to the main setup mode			
		CH1 or CH2 (flashing)	SEL SCrn	Displayed for two channel analyzer
	Press  to return to the channel specific menu options in the setup mode			Action required for two channel analyzer
		mA2 (flashing)	SEL SCrn	SEL CH1 or SEL CH2 on main display of two channel analyzer
	Press  to scroll to the next menu			

Default	Operator Action	Scrolling Marquee	Main Display	Notes
	mADJ	mADJ (flashing)	SEL SCrn	SEL CH1 or SEL CH2 on main display of two channel analyzer
	Press  to set the sensor and temperature mA offset values			
		SELECT mA1 OR mA2 OUTPUT	OUT1 or OUT2 (flashing)	
	Press  /  to scroll between OUT1 or OUT2 and select OUT1	SELECT mA1 OR mA2 OUTPUT	OUT1 (flashing)	
	Press  to accept the setting and advance to the next screen			
0.00		mA1 OUTPUT ADJUSTMENT	Adj 0 . 0 # (last flashing digit)	
	Press  /  to set the sensor mA offset value Press  to set a positive or negative sensor mA offset	mA1 OUTPUT ADJUSTMENT	Adj 0 . 0 # (change flashing digit)	
	Press  to accept the setting and return to the main setup mode			
		CH1 or CH2 (flashing)	SEL SCrn	Displayed for two channel analyzer
	Press  to return to the channel specific menu options in the setup mode			Action required for two channel analyzer
		mADJ (flashing)	SEL SCrn	SEL CH1 or SEL CH2 on main display of two channel analyzer
	Press  to set the sensor and temperature mA offset values			
		SELECT mA1 OR mA2 OUTPUT	OUT1 or OUT2 (flashing)	
	Press  /  to scroll between OUT1 or OUT2 and select OUT2	SELECT mA1 OR mA2 OUTPUT	OUT2 (flashing)	
	Press  to accept the setting and advance to the next screen			
0.00		mA2 OUTPUT ADJUSTMENT	Adj 0 . 0 # (last flashing digit)	
	Press  /  to set the temperature mA offset value Press  to set a positive or negative temperature mA offset	mA2 OUTPUT ADJUSTMENT	Adj 0 . 0 # (change flashing digit)	

























Default	Operator Action	Scrolling Marquee	Main Display	Notes
	Press  to accept the setting and return to the main setup mode			
		CH1 or CH2 (flashing)	SEL SCrn	Displayed for two channel analyzer
	Press  to return to the channel specific menu options in the setup mode			Action required for two channel analyzer
		mADJ (flashing)	SEL SCrn	SEL CH1 or SEL CH2 on main display of two channel analyzer
	Press  to scroll to the next menu			













Default	Operator Action	Scrolling Marquee	Main Display	Notes
	TEST	TEST (flashing)	SEL SCrn	SEL CH1 or SEL CH2 on main display of two channel analyzer
	Press  to test the mA outputs (4-20) and relays (rLY)			DIAGNOSTICS appears above SETUP in mode window
	To Test OUT2:			
4-20	Press  /  to scroll between 4-20 and rLY settings and select 4-20	SELECT mA OR RELAY	tESt 4 - 20 (flashing)	
	Press  to test 4-20 outputs			
		SELECT mA1 OR mA2 OUTPUT	4 - 20 OUT1 or OUT2 (flashing)	
	Press  /  to scroll between OUT1 and OUT2 settings and select OUT2	SELECT mA1 OR mA2 OUTPUT	4 - 20 OUT2 (flashing)	
	Press  to display the OUT2 low value			
Actual low value displayed		mA TEMP OUTPUT LOW VALUE	LO # . # c	4.0 mA are sourced at output terminal 11
	Press  to display the OUT2 high value			
Actual high value displayed		mA TEMP OUTPUT HIGH VALUE	HI # . # c	20.0 mA are sourced at output terminal 11
	Press  to accept the HI value and return to the main setup mode			
		CH1 or CH2 (flashing)	SEL SCrn	Display for two channel analyzer only
	Press  to return to the channel specific menu options in the setup mode			Action for two channel analyzer only

Default	Operator Action	Scrolling Marquee	Main Display	Notes
		TEST (flashing)	SEL SCrn	SEL CH1 or SEL CH2 on main display of two channel analyzer
	Press  to test the mA outputs (4-20) and relays (rLY)			
	To Test mA1:			
4-20	Press  /  to scroll between 4-20 and rLY settings and select 4-20	SELECT mA OR RELAY	tESt 4 - 20 (flashing)	
	Press  to test 4-20 outputs			
		SELECT mA1 OR mA2 OUTPUT	4 - 20 OUT1 or OUT2 (flashing)	
	Press  /  to scroll between OUT1 and OUT2 settings and select OUT1	SELECT mA1 OR mA2 OUTPUT	4 - 20 OUT1 (flashing)	
	Press  to display the mA1 low value			
Actual low value displayed		mA SENSOR OUTPUT LOW VALUE	LO # . #	4.0 mA are sourced at output terminal 9
	Press  to display the mA1 high value			
Actual high value displayed		mA SENSOR OUTPUT HIGH VALUE	HI # . #	20.0 mA are sourced at output terminal 9
	Press  to accept the test and return to the main setup mode			
		CH1 or CH2 (flashing)	SEL SCrn	Display for two channel analyzer only
	Press  to return to the channel specific menu options in the setup mode			Action for two channel analyzer only
		TEST (flashing)	SEL SCrn	SEL CH1 or SEL CH2 on main display of two channel analyzer
	Press  to test the mA outputs (4-20) and relays (rLY)			
	To Test rLY:			
4-20	Press  /  to scroll between 4-20 and rLY settings and select rLY	SELECT mA OR RELAY	tESt rLY (flashing)	
Actual rLY1 status	Press  to test relay outputs Press  /  to set the rLY1 setting OFF or On	USE ARROWS TO TOGGLE RELAY 1	rLY1 OFF or On	Relay contact according to screen indication
	Press  to accept the rLY1 test and move to the rLY2 test			

Default	Operator Action	Scrolling Marquee	Main Display	Notes
Actual rLY2 status	Press / to set the rLY2 setting OFF or On	USE ARROWS TO TOGGLE RELAY 2	rLY2 OFF or On	Relay contact according to screen indication
	Press to accept the rLY2 test and move to the rLY3 test			
Actual rLY3 status	Press / to set the rLY3 setting OFF or On	USE ARROWS TO TOGGLE RELAY 3	rLY3 OFF or On	Relay contact according to screen indication
	Press to accept the rLY3 test and return to the main setup mode			
		CH1 or CH2 (flashing)	SEL SCrn	Display for two channel analyzer only
	Press to return to the channel specific menu options in the setup mode			Action for two channel analyzer only
		TEST (flashing)	SEL SCrn	SEL CH1 or SEL CH2 on main display of two channel analyzer
	Press to scroll to the next menu			

Default	Operator Action	Scrolling Marquee	Main Display	Notes
	CAL	CAL (flashing)	SEL SCrn	SEL CH1 or SEL CH2 on main display of two channel analyzer
	Press to set the required calibration frequency			
0720		ENTER CALIBRATION FREQUENCY IN HOURS	CAL #### (first digit flashing)	To disable the calibration alarm, set the value to 0000
	Press / to set the first digit Press to move to the next digit Press / to set the values of the remaining digits and press to move through the remaining digits	ENTER CALIBRATION FREQUENCY IN HOURS	CAL #### (change flashing digit)	
	Press to accept the setting and return to the main setup mode			
		CH1 or CH2 (flashing)	SEL SCrn	Displayed for two channel analyzer
	Press to return to the channel specific menu options in the setup mode			Action required for two channel analyzer
		CAL (flashing)	SEL SCrn	SEL CH1 or SEL CH2 on main display of two channel analyzer
	Press to scroll to the next menu			

Default	Operator Action	Scrolling Marquee	Main Display	Notes
	DYN	DYN (flashing)	SEL SCrn	SEL CH1 or SEL CH2 on main display of two channel analyzer
	Press  to set custom DYN settings for the electrode calibration			
40 mL/ minute		SET SAMP FLOW RATE IN mL/M	FLO ###.# (flashing)	
	Press  /  to set the first digit Press  to move to the next digit Press  /  to set the values of the remaining digits and press  to move through the remaining digits	SET SAMP FLOW RATE IN mL/M	FLO ###.# (change flashing digit)	
	Press  to accept the setting and advance to the next screen			
100 ppm		SET STD CONCENTRATION	COnc ###.# (flashing)	
	Press  /  to set the first digit Press  to move to the next digit Press  /  to set the values of the remaining digits and press  to move through the remaining digits	SET STD CONCENTRATION	COnc ###.# (change flashing digit)	
	Press  to accept the setting and advance to the next screen			
10.1 % (chloride)		SET PUMP PERCENT FLOW FOR STD1	FLO ##.## (flashing)	
	Press  /  to set the first digit Press  to move to the next digit Press  /  to set the values of the remaining digits and press  to move through the remaining digits	SET PUMP PERCENT FLOW FOR STD1	FLO ##.## (change flashing digit)	
	Press  to accept the setting and advance to the next screen			
100		SET PUMP RANGE FOR STD1	rAn 100 (flashing)	
	Press  /  to scroll through 1, 10, 100 and 1000	SET PUMP RANGE FOR STD1	rAn 1, 10, 100 or 1000 (flashing)	
	Press  to accept the setting and advance to the next screen			

Default	Operator Action	Scrolling Marquee	Main Display	Notes
10.2 % (chloride)		SET PUMP PERCENT FLOW FOR STD2	FLO ##.## (flashing)	
	Press  /  to set the first digit Press  to move to the next digit Press  /  to set the values of the remaining digits and press  to move through the remaining digits	SET PUMP PERCENT FLOW FOR STD2	FLO ##.## (change flashing digit)	
	Press  to accept the setting and advance to the next screen			
10		SET PUMP RANGE FOR STD2	rAn 10 (flashing)	
	Press  /  to scroll through 1, 10, 100 and 1000	SET PUMP RANGE FOR STD2	rAn 1, 10, 100 or 1000 (flashing)	
	Press  to accept the setting and return to the main setup mode			
		CH1 or CH2 (flashing)	SEL SCrn	Displayed for two channel analyzer
	Press  to return to the channel specific menu options in the setup mode			Action required for two channel analyzer
		DYN (flashing)	SEL SCrn	SEL CH1 or SEL CH2 on main display of two channel analyzer
	Press  to scroll to the next menu			

Shutdown and Start-Up Procedure

The following steps should be taken if a loss of sample flow is expected for more than one day. These procedures will prevent possible build-up of caustic reagent vapors in the analyzer.

Shutdown

WARNING: Be sure to read and observe the following requirements.

Analyzer Shutdown

1. Shut off sample flow prior to the analyzer inlet. Refer to Section 4, Flow Cell Operation.
2. Disconnect the power. Refer to Section 2, Wiring the Analyzer.
3. Drain the flow cell.
4. Remove the reagent bottle and store it in a well-ventilated area such as a laboratory fume hood.

5. Carefully pull the iodide and reference electrodes out of the top of the flow cell and let them hang by their connectors.
6. Locate the protective cap from reference electrode kit and place it on the base of the reference electrode to prevent it from drying out.

Start-Up

1. Replace the diffusion tubing if the sample flow was off for more than a few days. Tubing becomes brittle with long-term exposure to the reagent. If the age of the reagent is not known, replace it and note the date in the maintenance records. Re-install the reagent bottle on the analyzer.
2. Restore sample flow to the analyzer. If necessary, adjust the pressure and flow rate through the analyzer to 40 mL/min.
3. Remove the protective cap from the reference electrode. Re-install the electrodes on the analyzer. Be careful not to disconnect the reservoir tubing from the reference electrode sidearm.
4. Allow the analyzer to stabilize for approximately 1 hour and then recalibrate the system. Refer to Section 4, Dynamic Calibrator Operation.

4

SECTION 4 **Calibration**

Calibration Setup

The Thermo Scientific Orion 2117LL chloride analyzer provides simple calibration cycles, 3-Point calibration procedure using a dynamic calibrator (Cat. No. 15DC15 for 115 V or Cat. No. 15DC20 for 220 V), and 1-Point offline calibration.

3 Point Calibration

1. If desired, check or edit the calibration related parameters in DYN under Setup mode.
 - Default sample flow rate: 40 mL/min
 - Default background concentration: 0 ppb
 - Default standard concentration: 100 ppm
 - Default pump percent for Std1: 10.1 (%)
 - Default pump range for Std1: 100 (1/100)
 - Default pump percent for Std2: 10.2 (%)
 - Default pump range for Std1: 10 (1/10)
2. Switch the sample line to background solution, default being “zero chloride” solution.
3. Place or mount the dynamic calibrator at a proper position near the monitor.
4. Load the 20-mL syringe with the standard chloride solution (default being 100 ppm chloride standard, Orion 941707); expel air.

5. Connect calibration tubing to syringe and prepare the dynamic calibrator as instructed in its manual. Take care not to touch the syringe fitting on the open end of the calibration tubing and protect this fitting from contamination.
6. Before connecting the calibration tubing to the injection port, turn the pump on at a moderate speed to expel all air in the tubing. After 1–2 mL of the standard solution dripping out of the open end of the tubing, change pump speed to slow setting (e.g., percent 10.1%, range 1/100, the default setting for introducing Std 1).
7. With the injection valve remaining shut off, install the calibration tubing to the inlet of the injection port then turn the pump off.
8. Make sure all fittings are hand tight.
9. Calibration procedures:
 1. Press “Cal”; choose DYN. Perform calibration by simply following the marquee on the top line of the analyzer display.
 2. Connect the sample to zero-chloride source and adjust flow to 40 mL/min. Wait for 30 min rinsing. (Pressing “Enter” will by-pass the waiting.)
 3. After the rinsing, the analyzer starts to measure the background.
 4. When the background is stable, the analyzer proceeds to the next step. This may take 4 min or longer.
 5. Set up the pump to desired setting; turn on the pump; open the injection valve to introduce the first standard.
 6. The analyzer starts to measure the first standard. When the measurement is stable, the analyzer proceeds to the next step. This may take 11 min or longer.
 7. Change the pump setting to desired number to introduce the second standard.
 8. The analyzer starts to measure the second standard. When the measurement is stable, the analyzer proceeds to the next step. This may take 9 min or longer.
 9. The analyzer displays the calibration results.

OffLine Calibration

The Offline calibration is simply a 1-Point Calibration using a standard whose concentration value is determined offline. The “offline” refers only to the fact that a sample from Orion 2117LL bypass is taken for laboratory analysis using alternative method. No downtime is experienced and the analyzer remains on-line throughout the procedure. Zero-chloride sample may be used as the standard of 0 ppb, or a known chloride concentration may be generated by using the dynamic calibrator.

1. Press “Cal”; choose offline calibration, OffL.
2. The analyzer starts to measure the sample for 2 minutes.
3. Collect a sample from bypass drain; analyze the sample in the lab.

4. At the display “Lab”, press “Enter”, the analyzer goes back to measurement mode.
5. After the lab result is obtained, press “Cal” and choose offline calibration.
6. Input the concentration value determined in the lab.
7. The analyzer displays a new E_0 value.
8. Press “Enter” to accept. The calibration is updated.

Flow Cell Operation

When the Thermo Scientific Orion 2117LL chloride analyzer is first commissioned, it is advisable to flush out the fluidics system overnight prior to the initial calibration and use. The electronics need not be turned on at this time.

- Install the sensing electrode, reference electrode and ATC probe in their respective flow cell holders. Refer to Section 2, Installation of a New Chloride Electrode; Section 2, Installation of the ATC Probe and Section 2, Installation of a New Reference Electrode.
- To ensure the analyzer achieves stability and to minimize interference during calibration, the operator should minimize activity on the system during calibration.
- Maximum system accuracy is ensured through a fast, easy and accurate calibration performed in the expected sample range. This calibration procedure uses equipment supplied in the calibration kit (Cat. No. 2117LLCAL) including the dynamic calibrator.
- Wait at least one hour to calibrate the analyzer after changing the reagent.
- Use an chloride-free sample during calibration.
- Fill and empty the syringe with standard at least three times before connecting the syringe to the dynamic calibrator.
- Always use a new syringe for each calibration.

Rinsing the Flow Cell

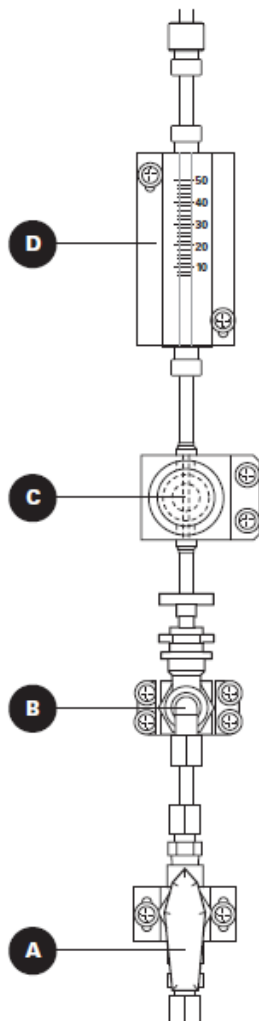

Figure 16: Fluidics Components

WARNING: Be sure to follow the procedure for rinsing the flow cell.

1. Open the sample inlet valve, see **A**.
 - Position the valve with the pointed end facing up for the open position.
2. Open the bypass/needle valve by turning it counterclockwise, see **B**.
 - Check for the appropriate sample flow.
 - Adjust the pressure regulator if required. See step 3.
3. Adjust the knob on the pressure regulator, see **C**, so the ball in the flow meter indicates the correct flow rate reading, see **D**. The flow rate should be adjusted to 40 mL/minute.
 - Pull out the knob to unlock the setting and adjust the flow rate.
 - Turn the knob clockwise to increase the flow rate.
 - Turn the knob counterclockwise to decrease the flow rate.
 - Push in the knob to lock the setting.

Dynamic Calibrator Operation

Figure 17

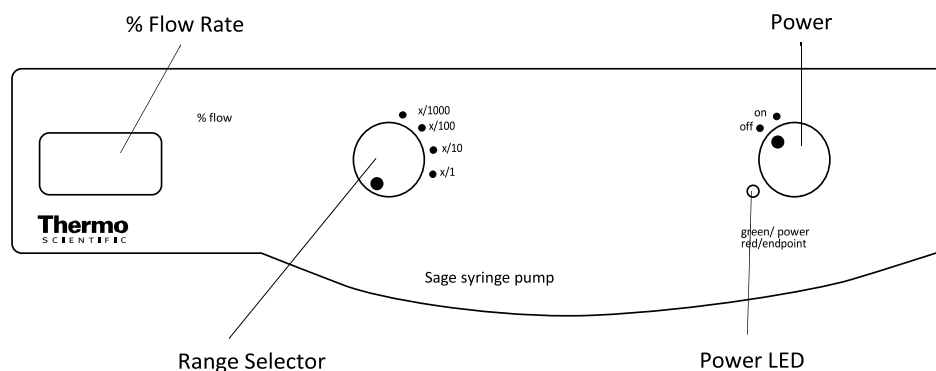

Dynamic Calibrator and Syringe Setup

The dynamic calibrator is used to deliver a standard solution to the 2117LL analyzer during calibration. Place the dynamic calibrator on a support near the analyzer. The calibrator location should be close enough to allow easy connection of the syringe tubing to the injection port on analyzer.







1. Connect the calibration tubing to the syringe using the luer adapter and the 1/4" female connector. Only hand tighten the components, do not overtighten them.
2. Loosen the blue knob on the dynamic calibrator by turning it approximately 1/4 of a turn clockwise and pressing up on the bottom, inside part of the blue knob. Lift the blue syringe holder and turn it away from the syringe cradle. Set the filled syringe in the center syringe cradle. Rotate the syringe holder back in place across the syringe. Gently tighten the blue knob by turning it 1/4 of a turn counterclockwise.
3. Lift the black drive carriage straight up. Move the carriage back and re-engage it with the gears, leaving room for the syringe. Check the alignment of the drive carriage to ensure it is perfectly straight.
4. Replace the drive carriage on the gears. Advance the carriage to meet the syringe by momentarily turning the pump on high speed.

Note: Do not attempt to push the carriage manually. This may result in damage to the pump mechanism.
5. Set the blue endpoint limiter midway between the white indicator marks.

Calibration Abort Steps

The system allows the operator to abort the calibration or return to the calibration when  is pressed at any point during the calibration.











The following table lists the calibration abort steps with their marquee display and required operator actions.

Step	Operator Action	Scrolling Marquee	Main Display	Notes
Calibration Abort Exit Steps – If  is pressed at any point during the calibration, proceed with the following steps				
Exit 1		ARE YOU SURE? PRESS ENTER TO ABORT OR PRESS LAST SCREEN TO BACKUP	SUR ?	
Exit 2	Press  to abort the calibration. or Press  to return to the last screen used in the calibration sequence prior to when  was pressed. Continue to follow the calibration steps according to the marquee and main display directions.	ARE YOU SURE? PRESS ENTER TO ABORT OR PRESS LAST SCREEN TO BACKUP	SUR ?	
Exit 3		CALIBRATION ABORTED PRESS ENTER	CAL Abt	
Exit 4	Press  to abort the calibration.	CALIBRATION ABORTED PRESS ENTER	CAL Abt	
Exit 5	Turn off the dynamic calibrator. Close the standard injection port by turning the thumbscrew 1/4 of a turn to the left, so the dot is perpendicular with the direction of the flow. Press  .	TURN PUMP OFF CLOSE INJECTION VALVE DOT DOWN PRESS ENTER		
Exit 6	No operator action needed. The system will enter the measure mode and remain on hold until the hold timer expires (default hold time is 30 minutes).	Actual temperature reading	Actual concentration reading	

Calibration Error Codes

At any point during a calibration, the appropriate error message will be displayed if there is a calibration related error.

The following table lists common calibration error codes with their marquee display and required operator actions.

Error	Operator Action	Scrolling Marquee	Main Display	Notes
Stability Time Out Error				
Error 41	Press  to continue the calibration despite the reading instability. or Press  to abort the calibration and refer to Exit 3. Repeat the calibration or refer to the troubleshooting section.	READINGS WERE UNSTABLE PRESS ENTER TO CONTINUE CALIBRATION OR PRESS EXIT TO ABORT	E041	The required system stability was not reached and a time out error occurred. Perform electrode cleaning, conditioning and troubleshooting.
Calibration Errors				
Error 42	Press  to abort the calibration and refer to Exit 3. Verify that the correct standards were used during the calibration, the standard values were entered correctly and in the right order and the electrodes are working properly and then repeat the calibration.	INVALID SLOPE PRESS ENTER	E042	The calculated slope was invalid. Standard values were likely entered in the wrong sequence or wrong standard values were entered.
Error 107	Press  to abort the calibration and refer to Exit 3.	CALIBRATION DATA TOO CLOSE TOGETHER PRESS ENTER	E107	Use new standards. Perform electrode cleaning, conditioning and troubleshooting.
Error 109	Press  to continue the calibration despite the bad slope. or Press  to abort the calibration and refer to Exit 3.	CH1 BAD SLOPE PRESS ENTER	E109	The calculated slope was outside of the recommended range. Perform electrode cleaning and conditioning, refer to the troubleshooting section and repeat the calibration.
Error 110	Press  to continue the calibration despite the bad slope. or Press  to abort the calibration and refer to Exit 3.	CH2 BAD SLOPE PRESS ENTER	E110	The calculated slope was outside of the recommended range. Perform electrode cleaning and conditioning, refer to the troubleshooting section and repeat the calibration.
Error 125	Press  to abort the calibration and refer to Exit 3. Verify that the correct standards were used during the calibration, the standard values were entered correctly and in the right order and the electrodes are working properly and then repeat the calibration.	CH1 BAD OFFSET PRESS ENTER	E125	Use new standards. Perform electrode cleaning, conditioning and troubleshooting.
Error 126	Press  to abort the calibration and refer to Exit 3. Verify that the correct standards were used during the calibration, the standard values were entered correctly and in the right order and the electrodes are working properly and then repeat the calibration.	CH2 BAD OFFSET PRESS ENTER	E126	Use new buffers or standards. Perform electrode cleaning, conditioning and troubleshooting.

Calibration At Custom Concentrations Using DYN

The Thermo Scientific Orion 2117LL chloride analyzer software has default values to accommodate standards added using the dynamic calibrator. The operator has the option to use alternate standards by changing, in the setup mode, the default values.

Chloride Default Values

Analyzer Flow Rate	= 40 mL/minute
Standard Concentration	= 100 ppm
Standard 1 Percent Flow	= 10.1%
Standard 1 Range	= x/100
Standard 2 Percent Flow	= 10.2%
Standard 2 Range	= x/10

Dynamic Calibrator Check

- The normal flow rate from the 20 cc syringe when the dynamic calibrator percent flow dial is set to 500 (equals 50% flow) and when the range switch is set at x/1 is 20 mL/minute. Therefore, the flow rate at x/10 is 2 mL/minute and at x/100 is 0.2 mL/minute.
- Place a 10 mL graduated cylinder so that the calibration tubing will reach the top of the cylinder.
- Turn the pump range switch to x/100 and allow the flow to begin and to fill the tubing completely, purging all air bubbles.
- Simultaneously, insert the calibration tubing into the mouth of the graduated cylinder and start a stopwatch.
- Allow the flow to continue into cylinder for exactly ten minutes. Remove the tubing from the cylinder and the pump off.
The total volume of the graduated cylinder should be 2.0 ± 0.1 mL.
If the total volume is not 2.0 ± 0.1 mL, the flow rate dial may be adjusted using the following formula:
adjusted flow rate setting = present setting x $\frac{\text{expected total volume}}{\text{actual total value}}$

For example, if the actual total flow was 1.8 mL, the new flow rate setting will equal
= $(500) \times (2.0/1.8) = 555$
- Perform the same flow rate check with the range switch on x/10 using a 50 mL graduated cylinder. Set the percent flow dial to read 500 (50.0%).
- Allow the flow to continue into cylinder for exactly five minutes. Remove the tubing from the cylinder and turn the pump off.

The total volume of the graduated cylinder should be 10.0 ± 1.0 mL.















Fine adjustment of the flow rate dial may be made if the total flow is different from the specified amount.

















For example, if the actual total volume was 11.0 mL, the new flow rate setting will equal
 $= (500) (10.0/11.0) = 455$

Note: For the best possible accuracy for the dynamic calibrator check, weigh volumes delivered for use in calculations.

Offline Calibration Procedure

The offline calibration feature is simply a one point calibration without slope change. The term “offline calibration” refers only to the fact that a sample from 2117LL bypass is taken “offline” for laboratory analysis; in fact, no downtime is experienced and the analyzer remains online throughout the procedure.

Step	Operator Action	Scrolling Marquee	Main Display	Notes
1	Open the bypass/needle valve to redirect the sample flow.	Actual temperature reading	Actual concentration reading	
2	Press  to initiate the calibration.			HOLD and CAL appear as mode.
3	If the calibration password is active, enter the calibration password by pressing  /  to set the first digit,  to move to the next digit,  /  to set the values of the remaining digits and  to move through the remaining digits. Press  to accept the password.	ENTER PASSWORD	PASS ####	
4		CH1 or CH2 (flashing)	CAL CHnL	Displayed for two channel analyzer
5	Press  /  to select the channel that will be calibrated and press  to begin the calibration.	CH1 or CH2 (flashing)	CAL CHnL	Action required for two channel analyzer
6		DYN or OFFL (flashing)	CAL tYPE	
7	Press  /  to select OFFL and press  to accept the setting.	OFFL (flashing)	CAL tYPE	
8	Wait 1 to 10 minutes.	MEASURING SAMPLE WAIT 1 MINUTE AWAITING DATA STABILITY	Actual readings flashing	System continuously evaluates the data until a stable condition is met.
9	Take a QC sample from the 2117LL analyzer bypass for laboratory analysis. Press  .	TAKE SAMPLE FROM BYPASS DRAIN PRESS ENTER TO USE METER THEN PRESS CAL TO ENTER LAB RESULTS	LAB	

Step	Operator Action	Scrolling Marquee	Main Display	Notes
10	Perform laboratory analysis on QC sample and return with results.	Actual temperature reading	Actual concentration reading	System will return to measure mode and operate as normal. CAL and MEASURE appear as mode.
11	Press  to resume the calibration.			HOLD and CAL appear as mode.
12	If the calibration password is active, enter the calibration password as described in step 3. Press  to accept the password.	ENTER PASSWORD	PASS ####	
13		CH1 or CH2 (flashing)	CAL CHnL	Displayed for two channel analyzer
14	Press  /  to select the channel that will be calibrated and press  to begin the calibration.	CH1 or CH2 (flashing)	CAL CHnL	Action required for two channel analyzer
15	Press  /  to select OFFL and press  to accept the setting.	OFFL (flashing)	CAL tYPE	
16	Enter the concentration value of the QC sample obtained from laboratory analysis: Press  to move the decimal point and set the value as ppm or ppb. Press  /  to set the first digit. Press  to move to the next digit. Press  /  to set the values of the remaining digits and press  to move through the remaining digits. Press  to save the value.	LAB ANALYSIS READY INPUT CONC VALUE FROM LAB PRESS ENTER TO CONTINUE OR PRESS EXIT TO ABORT	COnc ###.## (change flashing digit)	
17		NEW CALIBRATION E ₀ PRESS ENTER TO ACCEPT OR PRESS EXIT TO ABORT	Actual E ₀ value	The system will display the recalculated the E ₀
18	Press  .			The system will return to the measure mode. Only MEASURE should appear as mode.

5

SECTION 5 **Analyzer Maintenance**

Maintenance Schedule

The Thermo Scientific Orion 2117LL chloride analyzer is designed for simple maintenance. Follow the instructions in this section to ensure proper operation of your analyzer.

Recommendations

To ensure proper maintenance and good analyzer performance, a service logbook should be kept.

- Record maintenance date and the type of service work completed.
- Mark the date and the fluid levels of the reagent and the date when it was replaced.
- Tag each electrode cable with the installation date of the electrode.

Weekly Maintenance

1. Check that the sample flow rate is 35 to 45 mL/minute. To alter the flow rate, pull out the locking knob of the pressure regulator, then rotate the black knob to increase (clockwise) or decrease (counterclockwise) sample flow. Push in the locking knob of the pressure regulator to lock the flow rate.
2. Inspect the analyzer for leakage. Diffusion tubing leakage is indicated by a rise in the level of reagent. An easy way to determine this is to place a mark at the level of reagent after calibration. Check before next calibration. If the amount of reagent is higher then this is a clear indicator of a leak in the diffusion tubing.

3. Check that there are no error indications and that the current concentration level is reasonable.
4. Check that the reference filling solution is adequate. Replace if reservoir is less than half full.
5. If required, wipe the analyzer with a damp cloth to remove dirt and dust particles.

Monthly Maintenance

Calibration frequency is operator dependent for the most accurate and precise measurements.

Calibration

- Replacement of the reagent requires calibration. Refer to Section 4, Dynamic Calibrator Operation.
- Calibration intervals can be programmed using the setup mode. This will prompt the operator to recalibrate after a specific amount of time has passed. Refer to Section 3, Use of the Setup Mode.

Reference Electrode Filling Solution Replacement

The reference electrode filling solution needs to be replaced approximately every few months. If the reservoir is less than one quarter full, replace the solution. This should be checked monthly to ensure that the electrode does not run dry. Typical fill solution flow cause bottle level to drop 1/8" to 1/4" per month.

1. Remove the spent electrolyte bottle from the clip. Unscrew the cap and discard the bottle. Replace if necessary with cat #2117F4.
2. Remove the cap and seal from the new reference electrode filling solution. Check that the rubber gasket is properly aligned and then connect the cap and tubing assembly to bottle. The 1/8" tubing should extend into the bottle.
3. Invert the electrolyte bottle and snap it into the clip.
4. To vent bottle, puncture base with pin supplied with reference electrode. Make 3-4 holes to ensure proper venting.

Replacement of Sample Inlet Filter

1. If the sample flow can be adjusted with the pressure regulator to 50 mL/minute or more, skip this procedure. Also make sure the check that the inlet sample pressure is at least 10 PSIG.
2. Turn off sample flow by turning the inlet valve to the right.
3. Remove the filter hex cap using a 1 inch open-ended wrench.
4. Separate the filter cap with bypass/needle valve assembly from the filter body, retaining the ring.
5. Remove the filter element and soft gasket (if necessary).

6. Replace the gasket and press a new sintered element into the filter body.
7. Replace the hex cap and bypass/needle valve assembly and reposition the bypass drain line into the drain assembly.
8. Retighten the hex cap to approximately 75 pound-inch in torque.
9. Turn on the sample flow by turning the inlet valve left.
10. Check for leaks.

Polish Chloride Electrode

Refer to Section 2, Installation of a New Chloride Electrode.

Polish the chloride electrode according to the instructions that are included with the polishing strips supplied with sensing electrode.

Rinse the electrode thoroughly with distilled water, insert the chloride electrode into its holder in the flow cell and then plug the electrode cable marked "Sensing" into the top of the electrode.

Bi-Monthly Maintenance

WARNING: The reagent is hazardous. Use protective glasses and gloves and work in a wellventilated area. Avoid contact with skin or clothes. In case of skin contact, flush skin immediately with water to prevent burns. Refer to the bottle label for precautions.

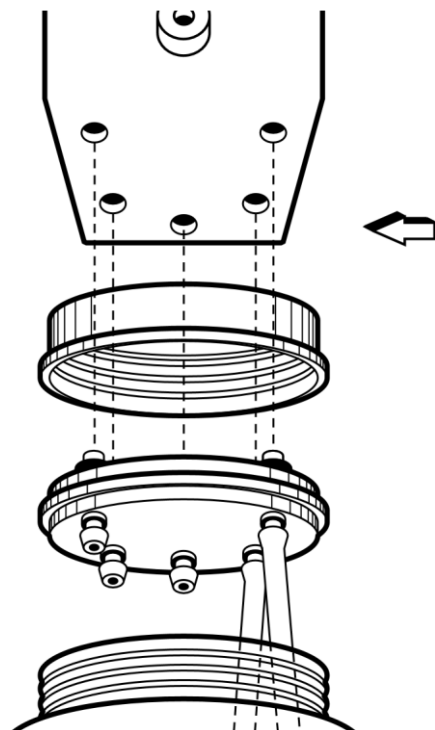

Figure 18: Reagent Bottle Assembly

Replacement of Reagent and Diffusion Tubing Assembly

1. Support the bottom of the reagent bottle and release the holding clamp with one hand. Turn the thumbscrew counterclockwise to release the reagent bottle. Unscrew the white bottle cap and gray tubing connector assembly. Since the reagent contains concentrated acid, which is very corrosive to skin and eyes, take the reagent to a well ventilated area such as a laboratory fume hood. Wear rubber gloves and eye goggles. Unscrew the cap and pour the old reagent into a suitable waste container.
2. Take a new bottle of the reagent (Cat. No. 182011) to a well ventilated area, such as a laboratory fume hood. Unscrew and remove the white cap on the bottle.
3. Connect the diffusion tubing (in kit) to the tubing connector assembly. Place the tubing assembly and cap into the bottle, Refer **Note 1**.
4. Replace the gray cap and screw the white cap on tightly.
5. Insert the five nipples on the top of the reagent bottle into the fluid connector block.
6. Support the bottom of the reagent bottle with one hand and tighten the thumbscrew clockwise.
7. Clamp the bottle to the fluidics panel to secure it.

Note 1: Replace the small O-rings (supplied with tubing) on the 5 top pins and around the base of the cap.

Yearly Preventive Maintenance

Electrodes

1. Replace the Thermo Scientific Orion reference electrode (Cat. No. 100057). Refer to Section 2, Installation of a New Reference Electrode for step-by-step instructions.
2. Replace the Thermo Scientific Orion Chloride sensing electrode (Cat. No. 100025). Refer to Section 2, Installing a New Chloride Electrode for step-by-step instructions.
3. Replace the calibration standard solutions (Cat. No. 941707).

Dispose of all old solutions according to the SDS instruction. The SDS files can be downloaded at www.thermofisher.com/water.

O-ring Replacement

Replace the electrode holder and micro-valve O-rings every year in addition to changing the reagent and tubing connector assembly barb O-rings every month. Both O-rings are included in the O-ring kit (Cat. No. 181060).

Replacement of the Restrictor Tubing

Use the restrictor tube assembly (Cat. No. 2100RT). Refer to Figure 19 for the restrictor tubing connections.

1. Close the inlet valve to stop sample flow through the analyzer.
2. Loosen the restrictor tube fitting connection from the top of the flow meter.
3. Remove the screw holding the clamp. Renumber the rest appropriately.
4. Pull out the restrictor tube assembly at each end.
5. Replace with a new restrictor tubing assembly.
6. Be sure all of the fittings are secure, to prevent leaks.
7. Open the inlet valve to start sample flow through the analyzer.

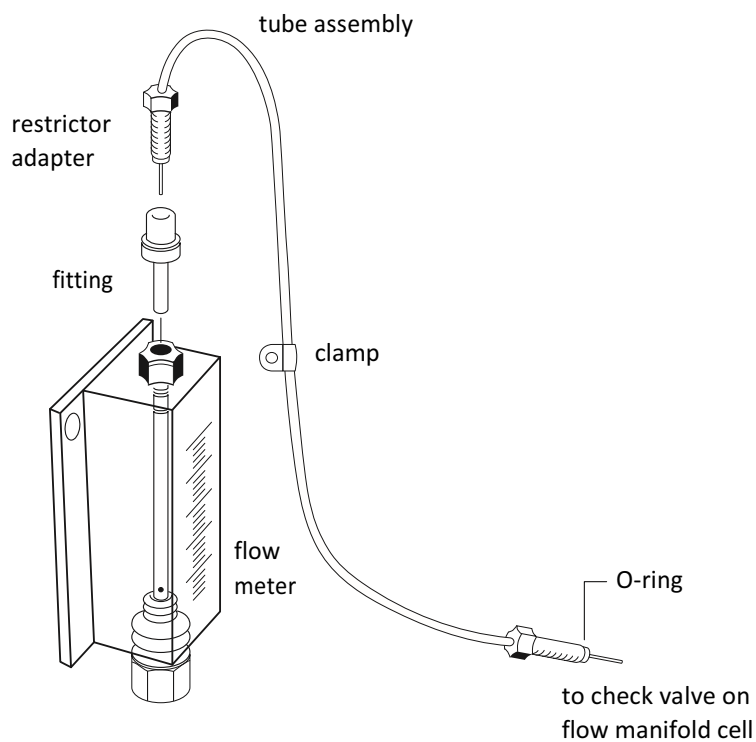

Figure 19: Restrictor Tubing

6





SECTION 6 Troubleshooting



The following section covers troubleshooting that can be performed without special tools or skills. Note that in most installations, the temperature in the flow cell should read between 0 - 15 °C, millivolt reading between +250 to +100 should be observed. High range slopes between -48 to -62 mV/decade, low range slope slop between -0.47 to -0.67 mV/ppb should be obtained. In the U.S., Thermo Scientific Customer Support can be consulted for troubleshooting advice at 1-800-225-1480 except within Massachusetts, call 978-232-6000. Outside the U.S. contact your local Thermo Scientific Dealer.

Malfunction	Possible Cause	Remedy
Low Slope	Improper calibration technique	Recalibrate
Low Slope	Sensing electrode defective	Replace and recalibrate
Low Slope	Calibration standards contaminated	Recalibrate with fresh standards
Low Slope	Zero-Chloride solution contaminated	Replace and recalibrate
Low Slope	Pipet failure	Refer to pipet manual
Low Slope	Standard 1, 2, and Standard 3 interchanged	Recalibrate
Low Slope	Electronics failure	Technical service 800-225-1480
Low Slope	Defective calibrator	Check dynamic calibrator flow rate
Slope Positive	Reference & sensing cables interchanged	Swap Cables
High Slope	Improper calibration technique	Recalibrate
High Slope	Sensing electrode defective	Replace



Malfunction	Possible Cause	Remedy
High Slope	Standards contaminated	Recalibrate with fresh standards
High Slope	Electronics failure	Technical service 800-225-1480
High Slope	Background concentration too high for standards used	Use higher standards
High Slope	Slow responding sensing electrode defective, calibrator again	Polishing sensing electrode and recalibrate
Noisy	Reference electrolyte not flowing	Make sure electrolyte bottle is flowing properly. Check bottle has been vented
Noisy	Electrode failure	Replace electrode
Excessive Drift	Reference electrolyte not draining properly	Make sure electrolyte bottle is vented - check tubing to electrode for obstruction
Excessive Drift	Reference electrode	Replace reference electrode
Excessive Drift	Chloride electrode	Replace sensing electrode
Excessive Drift	Burst diffusion tubing	Monitor liquid level in reagent bottle. If liquid level rises, replace reagent & diffusion tubing. Tubing connector may need replacement if leaking.
Low Flow Rate	Sample pressure below 8psi	Check sample pressure. If less than 8psi, increase
Low Flow Rate	Pressure regulator set too low	Increase pressure by pulling on red locking ring and turning black knob clockwise
Low Flow Rate	Bypass filter clogged	Replace or clean filter
Low Flow Rate	Restrictor tubing crimped or clogged	Replace restrictor tubing
Does Not Calibrate Properly	Contaminated standard	Use new standard solution
Does Not Calibrate Properly	Reagent spent	Replace reagent
Does Not Calibrate Properly	Electrode failure	Replace one or both electrodes
Does Not Calibrate Properly	Temperature probe failure	Replace or consult Technical Service
Does Not Calibrate Properly	Inaccurate standards or defective calibrator	Use new standard solution, check dynamic calibrator flow rate
High Readings	Monitor out of calibration	Recalibrate
High Readings	Inlet filter just replaced	Flush 1 hour until reading stabilizes. If offline calibration performed, verify accuracy of alternate method value









Diagnostics Mode

- From the measure mode, press  to enter the diagnostics mode. The  key allows access to menus used for system diagnostics.
- Each menu is sequential. Press  to scroll through the diagnostics menu selections.
-  can be pressed at any time to return to the measure mode.



Default	Operator Action	Scrolling Marquee	Main Display	Notes
	Diagnostics			
	<p>Press  while in the measure mode to enter the diagnostics mode.</p> <p>The system will enter the diagnostics mode at the calibration log menu.</p> <p>Press  to step through the menu items.</p>	CH1 CALIBRATION SLOPE AND E ₀ CH2 CALIBRATION CELL CONSTANT CH1 ERROR LIST PRESS VIEW CH2 ERROR LIST PRESS VIEW CH1 – SELECT TIME/DATE TO VIEW MEASUREMENT LOG CH2 – SELECT TIME/DATE TO VIEW MEASUREMENT LOG SELECT TIME/ DATE TO VIEW STATUS LOG SOFTWARE REV NUMBER CH1 SERIAL NUMBER CH2 SERIAL NUMBER CH1 MODEL NUMBER CH2 MODEL NUMBER CH1 MEASURE mV AND NOISE CH2 MEASURE mV AND NOISE CH1 mA1 and mA2 OUTPUT VALUES SENSOR/TEMP CH2 mA1 and mA2 OUTPUT VALUES PRESS ENTER FOR THE DISPLAY TEST PRESS ENTER TO CONTINUE PRESS ENTER TO CONTINUE KEYPAD TEST PRESS ALL KEYS ONE AT A TIME	The display will change with each menu	If only one board is installed in the analyzer, only one menu option will be shown in the scrolling marquee instead of CH1 and CH2 menu options.





Calibration Log

- Displays up to the last twelve calibrations using three screens:
 1. Slope and E₀ (analyzers with a pH module or ISE module installed), mV offset (analyzers with an ORP module installed) or cell constant (analyzers with a conductivity module installed)
 2. Date and Time
 3. Temperature
- Press  to scroll between the three information screens for each calibration
- Press  /  to view the last twelve calibrations



Default	Operator Action	Scrolling Marquee	Main Display	Notes
	Calibration Log			
	Press  while in the measure mode to enter the diagnostics mode			
	or or	CALIBRATION SLOPE AND E ₀	##.# (Slope) ##.# (E ₀)	
		CALIBRATION OFFSET	###.# (mV offset)	
		CALIBRATION CELL CONSTANT	#.### (Cell Constant)	
	Press  to display the calibration time and date	CALIBRATION TIME/DATE	HH:MM MM/DD or DD/MM	Press  /  to scroll through the last 12 calibrations
	Press  to display the calibration temperature and electrode response	CALIBRATION TEMP	##.# c (Temperature)	Press  /  to scroll through the last 12 calibrations
	Press  to proceed to the next menu			





Error List

- Displays a list of system events, warnings, and error codes that cause the yellow or red LED to light.
- The top line of the main display shows the error code and the bottom line shows the number of error codes (1-5 indicates that one of five error codes is being displayed).
- Press  /  to scroll through the error list.
- Press  to display a description of each error code on the marquee.



Default	Operator Action	Scrolling Marquee	Main Display	Notes
	Error List			
		ERROR LIST PRESS VIEW	E### # - #	
	Press  to display the description of the error code on the marquee	Actual description of error code	E### # - #	
	Press  /  to scroll through the error list	Actual description of error code	E### # - #	
	Press  to proceed to the next menu			

Measurement Log

- Displays logged measurements according to log interval entered in setup mode.
- Press  to toggle between the measurement value and the data and time.
- Press  /  to scroll through the log entries





Default	Operator Action	Scrolling Marquee	Main Display	Notes
	Measurement Log			
		SELECT TIME/DATE TO VIEW MEASUREMENT LOG	HH:MM MM/DD or DD/MM	
	Press  /  to scroll through the log entries	SELECT TIME/DATE TO VIEW MEASUREMENT LOG	HH:MM MM/DD or DD/MM	
	Press  to scroll between the measurement log and the data and time display	Actual temperature value for logged measurement	Concentration and mV values for logged measurement	
	Press  to proceed to the next menu			

Status Log

- Displays a list of system events.
- Press  /  to scroll through the log entries.
- Press  to toggle between the log code and the data and time.

Software Revision

- Displays the software revision numbers of the two processors.

Default	Operator Action	Scrolling Marquee	Main Display	Notes
	Status Log			
		SELECT TIME/DATE TO VIEW STATUS LOG	HH:MM MM/DD or DD/MM	
	Press  /  to scroll through the log entries	SELECT TIME/DATE TO VIEW STATUS LOG	HH:MM MM/DD or DD/MM	
	Press  to toggle between the log code and the data and time	PRESS UP/DOWN KEY TO VIEW STATUS LOG	Event code	
	Press  to proceed to the next menu			
	Software Revision			
		SOFTWARE REV NUMBER	r # . ## r # . ##	
	Press  to proceed to the next menu			

Electronics Serial Number

- Displays the serial number of the electronics assembly.

Model Number





- Displays the model number of the system. An E will be displayed if the analyzer is set to the ELIMIN-OX[®] application mode and an H will be displayed if the analyzer is set to the hydrazine application mode.

mV and Noise Measurements





- Displays the current mV measurement value and the noise associated with the measurement.





mA Output Values

- Displays current mA values for mA1 and mA2 outputs.

Default	Operator Action	Scrolling Marquee	Main Display	Notes
	Electronics Serial Number			
		SERIAL NUMBER	### ###	
	Press  to proceed to the next menu			
	Model Number			
		MODEL NUMBER	#### ####	
	Press  to proceed to the next menu			
	mV and Noise Measurements			
		MEASURE mV AND NOISE	Current mV measurement and noise	
	Press  to proceed to the next menu			
	mA Output Values			
		mA OUTPUT VALUES mA1/ mA2	Current mA output values for mA1 and mA2	
	Press  to proceed to the next menu			

Display Test

- Press  to start display test.
 1. All the display segments will light up and the system will cycle through the LED colors.
 2. Verify that all the display segments are on and that the LED colors are functional and press .
 3. All the display segments will turn off except for the marquee display, which should show **PRESS ENTER TO CONTINUE**.
 4. Verify that all the display segments are off and press .
 5. The system will show a counting number pattern on both lines of the main display.
 6. Verify that the display segments are functional and press  to proceed to the keypad test.

Default	Operator Action	Scrolling Marquee	Main Display	Notes
	Display Test			
		PRESS ENTER FOR THE DISPLAY TEST	dISP tEST	
	Press  to start the test			
	Verify that all of the display segments are on and that the LED colors are functional	All segments on	All segments on	System will cycle through the LED colors
	Press  to proceed to the next part of the test			
	Verify that all of the display segments are off	PRESS ENTER TO CONTINUE	All segments off	
	Press  to proceed to the next part of the test			
	Verify that all of the numeric display segments are functional	PRESS ENTER TO CONTINUE	Count pattern Count pattern	
	Press  to proceed to the next menu			

Keypad Test

- The main display will show **0** and the marquee will display **KEYPAD TEST PRESS ALL KEYS ONE AT A TIME.**
- Press all eight keys one at a time in any order.
- After the first key is pressed Error E033 will be displayed if a new key is not pressed within 10 seconds.

Default	Operator Action	Scrolling Marquee	Main Display	Notes
	Keypad Test			
		KEYPAD TEST PRESS ALL KEYS ONE AT A TIME	0	
	Press all keys one at a time in any order	KEYPAD TEST PRESS ALL KEYS ONE AT A TIME	Display will show numbers 1 through 8 as keys are pressed	After the first key is pressed error E033 will be displayed if a new key is not pressed within 10 seconds
	No operator action needed The system will enter the measure mode if the keypad test is passed			

Slope Problems

Low Slope

Slope less than -40 mV/decade

- Check the electrode function, clean the electrode, recalibrate the analyzer, and if the analyzer continues to read low, replace the electrode.
- An chloride-free sample must be used for calibration.
- Check electronics to read mV input correctly. Use electronic test kit (Cat. No. 180029) procedure for checking electronics function.

Ion-selective electrodes (ISE) can be shown as DC-voltage sources with 50 to 1000 Megohm; a very high output impedance. ISEs respond to ion concentration changes with a voltage change of approximately -59 mV/decade for monovalent anions such as iodide. Knowing electrode and analyzers parameters like offset potential, slope, etc allows testing of various instruments by applying a known mV voltage.

Input Signal	Expected Reading: $\pm (0.5 \text{ mV} + 0.1\%)$
0 mV	- 0.5 mV to + 0.5 mV
- 1000 mV	-1001.5 mV to - 998.5 mV
+ 1000 mV	+ 998.5 mV to + 1001.5 mV

- Standards contaminated or incorrectly made – verify calibration with fresh standards.
- Standard 1 and standard 2 values not set correctly – check the percent flow rate setting and range setting on the dynamic calibrator and in the setup mode of the analyzer. If using a custom standard, verify the values for the dynamic calibrator.
- Standard 1 and standard 2 added in wrong sequence – check the sequence of the standards and repeat the calibration.
- pH adjustment is not correct – check the level and flow of the reagent. Replace the reagent if it is contaminated or the level is less than 50 mL. Refer to Chapter 2, Installation of Reagent and Diffusion Tubing.

High Slope

Slope greater than -62 mV/decade

- Improper calibration technique – refer to Section 4, Dynamic Calibrator Operation.
- Calibration standards contaminated – repeat the calibration using fresh standards.
- Electronics failure – reset the analyzer. Refer to Section 6, Resetting the Analyzer.
- Improper dynamic calibrator settings – refer to Section 4, Dynamic Calibrator Operation.
- An oxygen scavenger-free sample must be used for calibration.
- Cables interchanged – verify wiring of cable connections to terminal strip. Refer to Section 2, Wiring the Analyzer.
- Check the connection of the cable markers for the corresponding electrode. Cable markers are the white tape at the cap connector on the cable.

- “Ref” for the reference electrode.
- “Sensing” for the iodide electrode.
- Sensing electrode coated – clean or replace the sensing electrode.

Troubleshooting Matrix

Malfunction	Possible Cause	Remedy
Noisy	Blocked junction on reference electrode	Make sure electrolyte is flowing properly and the bottle is pressurized by the air pump.
	Chloride or reference electrode failure	Check the cable connections and location of wiring to terminal strip. Refer to Section 2.
	Temperature probe failure	Disconnect ATC. Temperature should read 25 °C (E101). Replace if necessary.
	Calibration standard carryover	Disconnect the air pump intake tube. Rinse the flow cell and electrodes with deionized water by lifting the flow cell cap. Reconnect the air pump.
	Faulty electrode cables	Replace electrode cables.
Excessive Drift	Sample concentration varying	Check sample status. Perform a span check and if span check passes, the analyzer is okay.
	Blocked junction on reference electrode	Make sure electrolyte is flowing properly and the bottle is pressurized by the air pump.
	Chloride or reference electrode failure	Check the cable connections and location of wiring to terminal strip. Refer to Section 2.
	Reference electrode filling solution empty or incorrect solution used	Use Cat. No. 100057F4 reference electrode filling solution.
	Diffusion tubing burst	Observe the liquid level in the reagent bottle. If the liquid level rises, replace the reagent and diffusion tubing. The tubing connector may need replacement. Refer to Section 2.
	Temperature probe failure	Disconnect ATC. Temperature should read 25 °C (E101). Replace if necessary.
Low Flow Rate	Sample pressure below 8 psi	Check the sample pressure. If it is less than 8 psi, increase the pressure. Refer to Section 2.
	Pressure regulator set too low	Increase the pressure by pulling on the red locking ring and turning the black knob clockwise. Refer to Section 2.
	Inlet filter clogged	Replace or clean the filter.
	Restrictor tubing crimped or clogged	Replace the restrictor tubing. Refer to Section 2.
Does Not Calibrate Properly	Contaminated standard or syringe	Use new standard solution. Replace the syringe.
	Sample used for calibration contains an oxygen scavenger.	Oxygen scavenger-free sample must be used for calibration. Refer to Section 4.

Malfunction	Possible Cause	Remedy
	Temperature probe failure	Disconnect ATC. Temperature should read 25 °C (E101). Replace if necessary.
	Dynamic calibrator technique error	Use the correct techniques. Refer to Section 4.
	Reagent diluted or contaminated	Replace the reagent. Refer to Section 2.
	Flow cell contaminated	Rinse the flow cell with deionized water. Flush the flow cell overnight at calibration liquid level. Refer to Section 4.
	Electronics failure or bad setup	Reset the analyzer. Refer to Section 6.
High Readings	Analyzer out of calibration	Recalibrate the analyzer. Refer to Section 4.
	Flow cell contaminated	Rinse the flow cell with deionized water. Flush the flow cell overnight at calibration liquid level. Refer to Section 4.
	Inlet filter just replaced	Flush the analyzer for one hour. Refer to Section 4. If an offline calibration was performed, verify accuracy of alternate method value. Refer to Section 4.
	Reagent spent or diluted	Replace the reagent. Refer to Section 2.
Over-Range Readings	Electrode connections loose or bad	Verify the electrode connections to the electrode cables.
	Electrode wiring	Electrodes not properly wired to terminal strip. Refer to Section 2.
	Blocked junction on reference electrode	Make sure electrolyte is flowing properly and the bottle is pressurized by the air pump.
	Chloride or reference electrode failure	Electrode is shorted, cracked or damaged. Install a new electrode. Refer to Section 2.
	Electronics failure or bad setup	Reset the analyzer. Refer to Section 6.
	Analyzer out of calibration	Recalibrate the analyzer. Refer to Section 4.
Low Readings	Analyzer out of calibration	Recalibrate the analyzer. Refer to Section 4.
	Sample is very pure	Check sample status. Perform a span check and if span check passes, the analyzer is okay.
	Electronics failure	Try resetting the analyzer. Refer to Section 6 or consult Technical Support.
Default	Battery failure	Consult Technical Support.
	Electronics failure	Reset the analyzer. Refer to Section 6.

Error/Event Codes

Error/event codes will be in the format “E####”. Some of these are errors, some are warnings, and some are purely informational. The first digits identify the type of error or event as identified in the table below.

Displayed Event Code	Description	Cause	Troubleshooting
System Status Codes			
A711	ALARM1 CH1 ON	Alarm 1 channel 1 engaged (closed)	
A712	ALARM2 CH1 ON	Alarm 2 channel 1 engaged (closed)	
A713	ALARM3 CH1 ON	Alarm 3 channel 1 engaged (open)	
A714	AIR PUMP ON	Air pump engaged	
A721	ALARM1 CH2 ON	Alarm 1 channel 2 engaged (closed)	
A722	ALARM2 CH2 ON	Alarm 2 channel 2 engaged (closed)	
A723	ALARM3 CH2 ON	Alarm 3 channel 2 engaged (open)	
A811	ALARM1 CH1 OFF	Alarm 1 channel 1 disengaged (open)	
A812	ALARM2 CH1 OFF	Alarm 2 channel 1 disengaged (open)	
A813	ALARM3 CH1 OFF	Alarm 3 channel 1 disengaged (closed)	
A814	AIR PUMP OFF	Air pump disengaged	
A821	ALARM1 CH2 OFF	Alarm 1 channel 2 disengaged (open)	
A822	ALARM2 CH2 OFF	Alarm 2 channel 2 disengaged (open)	
A823	ALARM3 CH2 OFF	Alarm 3 channel 2 disengaged (closed)	
C500	CAL MODE	Calibration mode entered	
R400	MEAS MODE	Measure mode entered	
S600	SETUP MODE	Setup mode entered	
E028	POWER FAIL	Brown out or power failure and system has stopped processing	Verify custom settings
E033	KEYPAD FAILURE	User did not press the keys during a diagnostic mode keypad test or keypad broken	Repeat diagnostic mode keypad test
E034	CAL PASS INCORRECT	User entered incorrect calibration password	Verify password
E035	SYSTEM PASS INCORRECT	User entered incorrect system password	Verify password
E036	USER VALUE INCORRECT	User entered a value that is out of range	Verify value and re-enter
E037	POWER RETURN	System started processing after brown out or power failure	Verify custom settings
E040	BLANK INCORRECT	Blank greater than 1ppb	Verify scrolled blank value is correct
E041	CALIBRATION TIMEOUT	The electrode has not reach stability within the specified time	The system code may be due to out of range measurements or an invalid previous calibration
E042	INVALID SLOPE	Invalid slope obtained during calibration	Check electrodes, electrode cables and connectors for defects or shorts. Replace electrodes, if necessary. Recalibrate using new standards in the correct calibration sequence.

Displayed Event Code	Description	Cause	Troubleshooting
System Event/Error Codes - Yellow LED			
E004	DEFAULT VALUES	Analyzer has been reset or is new out of box	Calibrate the analyzer.
E021	HARDWARE FAULT	System error	Contact Technical Support 1-800-225-1480
E101	CH1 TEMP OUT OF RANGE	Temperature sensor on channel 1 out of range (5°C to 45°C) for ISE or 0°C to 15°C for 2117LL	Check ATC cable and probe connections. Replace if needed (for 2117LL verify refrigerated bath is working properly).
E102	CH2 TEMP OUT OF RANGE	Temperature sensor on channel 2 out of range (5 °C to 45°C) for ISE	Check ATC cable and probe connections. Replace if needed.
E111	CH1 CAL DUE	User calibration required on channel 1. No calibration has been performed in user specified time interval.	Recalibrate the analyzer.
E112	CH2 CAL DUE	User calibration required on channel 2. No calibration has been performed in user specified time interval.	Recalibrate the analyzer.
E127	CH1 mA1 OVER RANGE	Measured sensor value above mA1 high limit value on channel 1	Verify user selectable mA1 high limit value in setup mode
E128	CH1 mA1 UNDER RANGE	Measured sensor value below mA1 low limit value on channel 1	Verify user selectable mA1 low limit value in setup mode
E129	CH1 mA2 OVER RANGE	Measured temperature value above mA2 high limit value on channel 1	Verify user selectable mA2 high limit value in setup mode
E130	CH1 mA2 UNDER RANGE	Measured temperature value below mA2 low limit value on channel 1	Verify user selectable mA2 low limit value in setup mode
E131	CH2 mA1 OVER RANGE	Measured sensor value above mA1 high limit value on channel 2	Verify user selectable mA1 high limit value in setup mode
E132	CH2 mA1 UNDER RANGE	Measured sensor value below mA1 low limit value on channel 2	Verify user selectable mA1 low limit value in setup mode
E133	CH2 mA2 OVER RANGE	Measured temperature value above mA2 high limit value on channel 2	Verify user selectable mA2 high limit value in setup mode
E134	CH2 mA2 UNDER RANGE	Measured temperature value below mA2 low limit value on channel 2	Verify user selectable mA2 low limit value in setup mode









Displayed Event Code	Description	Cause	Troubleshooting
System Error Codes - Red LED			
E001	HARDWARE FAULT	System error	Contact Technical Support 1-800-225-1480
E002	HARDWARE FAULT	System error	Contact Technical Support 1-800-225-1480
E018	HARDWARE FAULT	System error	Contact Technical Support 1-800-225-1480
E019	HARDWARE FAULT	System error	Contact Technical Support 1-800-225-1480
E020	HARDWARE FAULT	System error	Contact Technical Support 1-800-225-1480
E024	HARDWARE FAULT	System error	Contact Technical Support 1-800-225-1480
E026	HARDWARE FAULT	System error	Contact Technical Support 1-800-225-1480
E027	HARDWARE FAULT	System error	Contact Technical Support 1-800-225-1480

Displayed Event Code	Description	Cause	Troubleshooting
E029	HARDWARE FAULT	System error	Contact Technical Support 1-800-225-1480
E030	HARDWARE FAULT	System error	Contact Technical Support 1-800-225-1480
E038	HARDWARE FAULT	System error	Contact Technical Support 1-800-225-1480
E103	CH1 MEAS OVER RANGE	Measurement is over range on channel 1, the display should also be flashing '9999'	Check if electrode is not connected, electrode cables are faulty or electrode junction is fouled.
E104	CH2 MEAS OVER RANGE	Measurement is over range on channel 2, the display should also be flashing '9999'	Check if electrode is not connected, electrode cables are faulty or electrode junction is fouled.
E109	CH1 BAD SLOPE	Last calibration produced a bad slope on channel 1. Slope is less than -40 mV/decade or more than -75 mV/decade or the calibration standards may have been interchanged.	Recalibrate the analyzer using fresh standards. Recalibrate using the correct sequence of standards.
E110	CH2 BAD SLOPE	Last calibration produced a bad slope on channel 2. Slope is less than -40 mV/decade or more than -75 mV/decade or the calibration standards may have been interchanged.	Recalibrate the analyzer using fresh standards. Recalibrate using the correct sequence of standards.
E113	CH1 CAL OVERDUE	Calibration is overdue on channel 1 by more than 50% of the user specified time interval	Recalibrate the analyzer.
E113	CH2 CAL OVERDUE	Calibration is overdue on channel 2 by more than 50% of the user specified time interval	Recalibrate the analyzer.
E121	CH1 TEMP BROKEN	Temperature sensor on channel 1 broken or out of range	Check ATC cable connections and probe for damage. Replace if needed.
E122	CH2 TEMP BROKEN	Temperature sensor on channel 2 broken or out of range	Check ATC cable connections and probe for damage. Replace if needed.
E125	CH1 BAD OFFSET	Last calibration produced a bad E_o offset on channel 1	Recalibrate the analyzer using fresh standards. Check electrode connections. Replace electrode, if needed.
E126	CH2 BAD OFFSET	Last calibration produced a bad E_o offset on channel 2	Recalibrate the analyzer using fresh standards. Check electrode connections. Replace electrode, if needed.

Resetting the Analyzer

The Thermo Scientific Orion 2117LL low level chloride analyzer allows the user to reset the analyzer through the setup mode or by a hard reset. Resetting the analyzer will restore all settings in the setup mode to factory default values.

WARNING: Resetting the analyzer will erase all data logs including calibration, and password protection settings for setup and calibration. The analyzer will reset setup parameters to factory default settings.

Operator Action	Scrolling Marquee	Main Display	Notes
Press  in the measure mode to enter the setup mode			
	Last menu used in setup mode	SEL SCrn	SETUP appears as mode.
Press  /  until RSET appears in the marquee			
	RSET (flashing)	SEL SCrn	
Press  to reset the analyzer			
	PRESS TEST VIEW ENTER TO RESET	rSet ?	
Press  Press  Press  When the reset is complete, the system will return to the measure mode. The operator will need to re-enter the setup mode to continue programming the setup parameters. Press  to return to the setup mode.	PRESS TEST VIEW ENTER TO RESET	rSet ?	This command resets all previously set parameters to factory default values. Use this command only to set the analyzer to original factory setup values.

Hard Reset

A hard reset should be performed if the analyzer becomes unresponsive or the status indicators are flashing. Perform the following sequence:

- Carefully open the front cover of the electronics case (loosen the four corner screws).
- Press the small button located on the raised portion of the PCB to reset the electronics.
- Close the front cover of the electronics case and tighten the screws.

System settings and calibrations are preserved and analyzer returns to the measure mode. The actual value for concentration and temperature will be displayed if the electrodes are properly installed. If the system does not reset, contact Technical Support at 1-800-225-1480 for assistance.

Serial Number and Software Revision

In the event you require technical assistance, please have the serial number available when calling for assistance along with the software version.

- The analyzer serial number is located on the underside of the electronics enclosure or if panel mounted then on the backside of the electronics enclosure.
- The software revision is accessed through the diagnostics mode.

Service and Repair

Extended Warranty

The Thermo Scientific Orion 2117LL low level chloride analyzer provides measurements through a combination of our premium electrode technology and user friendly scrolling marquee to set a new industry standard for reliability. Similarly, Thermo Fisher Scientific now offers multiple levels of service programs to meet your needs beyond the One-Year Product Warranty period.

A cost effective way to blend your in-house expertise with our service and support experts, to get the support you need at a specified annual contracted price. This warranty plan must be purchased within ninety days of the initial product purchase date.

- Extends the features of the standard One-Year Product Warranty for a second or third year.
- Provides access to the manufacturer's technical experts at Thermo Scientific Orion Support Call Center, 1-800-225-1480, Monday through Friday, 8:00 AM to 5:00 PM EST.
- After telephone consultation, we will send you required parts for installation by your on-site technician.

Service Kit to Expand Standard Warranty

With in-house resources at a premium, many organizations require immediate access to manufacturer expertise. Purchase a service kit within ninety days of the initial product purchase date to eliminate the costly effects of down time.

- Provides a contracted, cost-effective means to enhance level of support offered during the product warranty period.
- Provides priority access to the manufacturer's technical experts at Thermo Scientific Orion Support Call Center.
- Provides a service kit to expedite on-site repairs in conjunction with telephone consultation with Thermo Scientific Orion product experts.

The service kit includes:

- Power supply
- Front panel display
- Air pump
- Electrode cables

Advanced Replacement

When down-time is a cost factor to be strictly controlled, the advanced replacement service plan is often times the best choice.

- Enhances level of support offered during the standard One-Year Product Warranty.
- Provides access to the manufacturer's technical experts at Thermo Scientific Orion Support Call Center and repair facilities.

- If, after reasonable remote diagnostics and trouble-shooting attempts, we determine the analyzer to be non-functioning, we will make all reasonable effort to get required parts or equipment out to your facility by the following day for installation by your on-site technician.
- Offers predictable expenditure through fixed annual contract price.

Not sure which plan is best for you?

Ask your Thermo Scientific Orion products sales representative to put you in touch with the service plan manager. We have additional service options that are sure to address your concerns.

Installation and Start-Up

To help you achieve optimum performance, rely on us to provide you with an efficient and quality installation and the start-up support you need to be up and running quickly. Our service representatives are highly trained, experienced, and certified for your product and will be there to make sure that your instrumentation delivers to specifications.

Remedial Service

This is a one-day service engineer on-site visit to your facility for remedial service events at standard response time. Consider this plan an excellent uplift to one of the aforementioned programs.

Preventive Maintenance Programs

All precision-made scientific equipment requires preventive maintenance and calibration checks to perform at their maximum effectiveness. Consider a fixed-fee preventive maintenance contract to have one of our experts perform the following tasks:

- Sampling check
- Full validation test
- Visual check for worn, loose or damaged parts
- Replacement of consumables (additional charge for consumables)
- Diagnostic check to verify all operating parameters are within the factory specifications
- Check analyzer electrodes, flows and pressures
- Clean and replace any wearable items

7

SECTION 7 **Customer Service**

Notice of Compliance

This equipment generates, uses and can radiate radio frequency energy and if not installed and used in accordance with the user guide, may cause interference to radio communications. It has been tested and found to comply with the limits for a Class A computing device pursuant to Subpart J of Part 15 of FCC Rules, which are designed to provide reasonable protection against such interference when operated in a commercial environment. Operation of this equipment in a residential area is likely to cause interference in which case the user, at his own expense, will be required to take whatever measure may be required to correct the interference.

“This digital apparatus does not exceed the (Class A) limits for radio noise emissions from digital apparatus set out in the Radio Interference Regulations of the Canadian Department of Communications.”

Statement of Conformity



STATEMENT OF CONFORMITY



^[1] Manufacturer

Thermo Fisher Scientific
 22 Alpha Road
 Chelmsford, MA 01824
 USA

^[2] Authorized Representative

Thermo Electron LED GmbH
 Robert-Bosch-Str. 1
 63505 Langenselbold
 Germany

^[3] Product Type

Thermo Scientific Orion 2100 Series Analyzers

^[4] Model Name(s)

2102PH – pH/ORP Monitor	2117HL – High Level Chloride monitor
2104CD – Conductivity Monitor	2117LL – Low Level Chloride Monitor
2109XP – Fluoride Monitor	2117XP – Chloride Monitor
2110XP – Ammonia Monitor	2118XP – Oxygen Scavenger Monitor
2111LL – Low Level Sodium Monitor	2120XP – Calcium Hardness Monitor
2111XP – Sodium Monitor	

^[5] Rated Voltage, Rated Frequency

100-120V and 200-240V, 50/60 Hz

^[6] We herewith declare under our sole responsibility that the above mentioned products meet the provisions of the following EC Directives and harmonized standards:

^[7] EC Directives

2014/30/EU Electromagnetic Compatibility Directive
 2014/35/EU Low Voltage Directive
 2011/65/EU RoHS Directive

^[8] Standards

EN 61326-1:2013
 EN 61010-1:2010
 EN 50581:2012

^[9] This declaration is valid for the product(s) manufactured after the date listed below.

Chelmsford, MA
 15, December 2016

Shervin Ghorab
 Compliance Manager
 Thermo Fisher Scientific

271818-000 Rev. A

WEEE Compliance



This product is required to comply with the European Union's Waste Electrical & Electronic Equipment (WEEE) Directive 2012/19/EU. It is marked with the following symbol:

Thermo Fisher Scientific has contracted with one or more recycling/disposal companies in each EU Member State and this product should be disposed of or recycled through them. Further information on compliance with these directives, the recyclers in your country, and information on Thermo Scientific Orion products that may assist the detection of substances subject to the RoHS Directive are available at www.thermofisher.com/WEEERoHS.

Terms and Conditions

For products not listed in this warranty statement, please visit our website at www.thermofisher.com/water.

Contact Information

Thermo Fisher Scientific Inc.
 22 Alpha Road,
 Chelmsford, MA 01824, USA
 Toll Free: 800-225-1480
 Tel: 978-232-6000
 Dom. Fax: 978-232-6015
 Int'l Fax: 978-232-6031

Minimum Order

The minimum order requirement is \$100 for Thermo Scientific Orion process products. An order is considered to be a purchase order for products to be shipped to a single location. International minimum order requirements may vary. Contact your international coordinator for details.

Rush Orders

For customers in the U.S., rush orders received before 12 pm Eastern Time will be shipped the same day. Rush orders received after 12 noon Eastern Time will be shipped the next business day.

For customers and dealers in Canada, rush orders will be shipped within 2 business days. For customers and dealers outside the U.S. and Canada, contact your international coordinator for rush order scheduling. All rush orders carry a \$50 incremental charge per order. FOB: Beverly. Freight charges are prepaid and added or freight collect. All rush order processing is subject to stock availability.

Returning Goods

Permission to return Thermo Scientific Orion products must be obtained prior to return. Contact us within 30 days of receipt of goods for a return authorization number.

Hazardous Materials

Some materials are designated corrosive/oxidizer by DOT and IATA. Some materials may require special labeling and handling. Carriers may add additional freight charges for handling/transporting these materials. Consolidating such material with other products may be prohibited. Additional freight charges are billed to you per FOB terms. Advise manufacturer of shipping instructions for these hazardous materials to reduce your freight costs.

Restocking Charge

Permission to return new, excess inventory must be obtained prior to return. If any item is authorized to be returned for credit as a result of an incorrect purchase without a reorder, a 25% restocking charge of the price paid for the product will be made. International customer's restocking fee of 25% will be off the international price.

Only new (in the box) goods may be returned within 30 days of shipment from manufacturer. Older items, 9 digit parts and discontinued items cannot be returned for credit.

Short Shipments

Manufacturer must be notified within 30 days of receipt of invoice of any item or billing discrepancies. All substantiated claims will be remedied by a credit memo and a new order placed for short shipment. Any shipment discrepancy claimed after 30 days of invoice date will not be honored and credit will not be issued by manufacturer.

Force Majeure

Manufacturer shall not be liable for failure to perform or for delay in performance due to fire, flood, strike, or other labor difficulty, act of God, act of any governmental authority or of the purchaser, riot, embargo, fuel or energy shortage, wrecks or delays in transportation, inability to obtain necessary labor, materials, or manufacturing facilities from usual sources, or due to any cause beyond its reasonable control. In the event of a delay in performance due to any such cause, the date of delivery or time for completion of performance will be extended by a period of time reasonably necessary to overcome the effect of such delay.

Warranty

Thermo Scientific Orion process products are warranted to be free from defects in material and workmanship for a period of 12 months from date of installation or 18 months from date of shipment, whichever is earlier, when used under normal operating conditions and in accordance with the operating limitations and maintenance procedures given in the user guide and when not having been subjected to accident, alteration, misuse or abuse. This warranty is also conditioned upon expendable and consumable items (diffusion tubing, electrodes and all solutions) being stored at temperatures between 5 °C and 45 °C (40 °F and 110 °F) in a non-corrosive atmosphere and within the shelf life printed on the product.

In the event of failure within the warranty period, the manufacturer or its authorized dealer will, at the option of manufacturer, repair or replace the product nonconforming to the above warranty or will refund the purchase price of the product.

The warranty described is exclusive and in lieu of all other warranties whether statutory, express, or implied including, but not limited to, any implied warranty of merchantability or fitness for a particular purpose and all warranties arising from the course of dealing or usage of trade. The buyer's sole and exclusive remedy is for repair or replacement of the non-conforming part thereof, or refund of the purchase price, but in no event shall the manufacturer (its contractors and suppliers of any tier) be liable to the buyer or any person for any special indirect, incidental, or consequential damages whether the claims are used in contract, in tort (including negligence), or otherwise with respect to or arising out of the product furnished hereunder.

Process products used at overseas nuclear facilities are also subject to the manufacturer's nuclear terms and conditions. Contact the manufacturer if you do not have a copy.

Representations and warranties made by any person, including its authorized dealers, distributors, representatives, and employees of the manufacturer, which are inconsistent or in addition to the terms of this warranty shall not be binding upon manufacturer unless in writing and signed by one of its officers.

Appendix

Mounting Dimensions

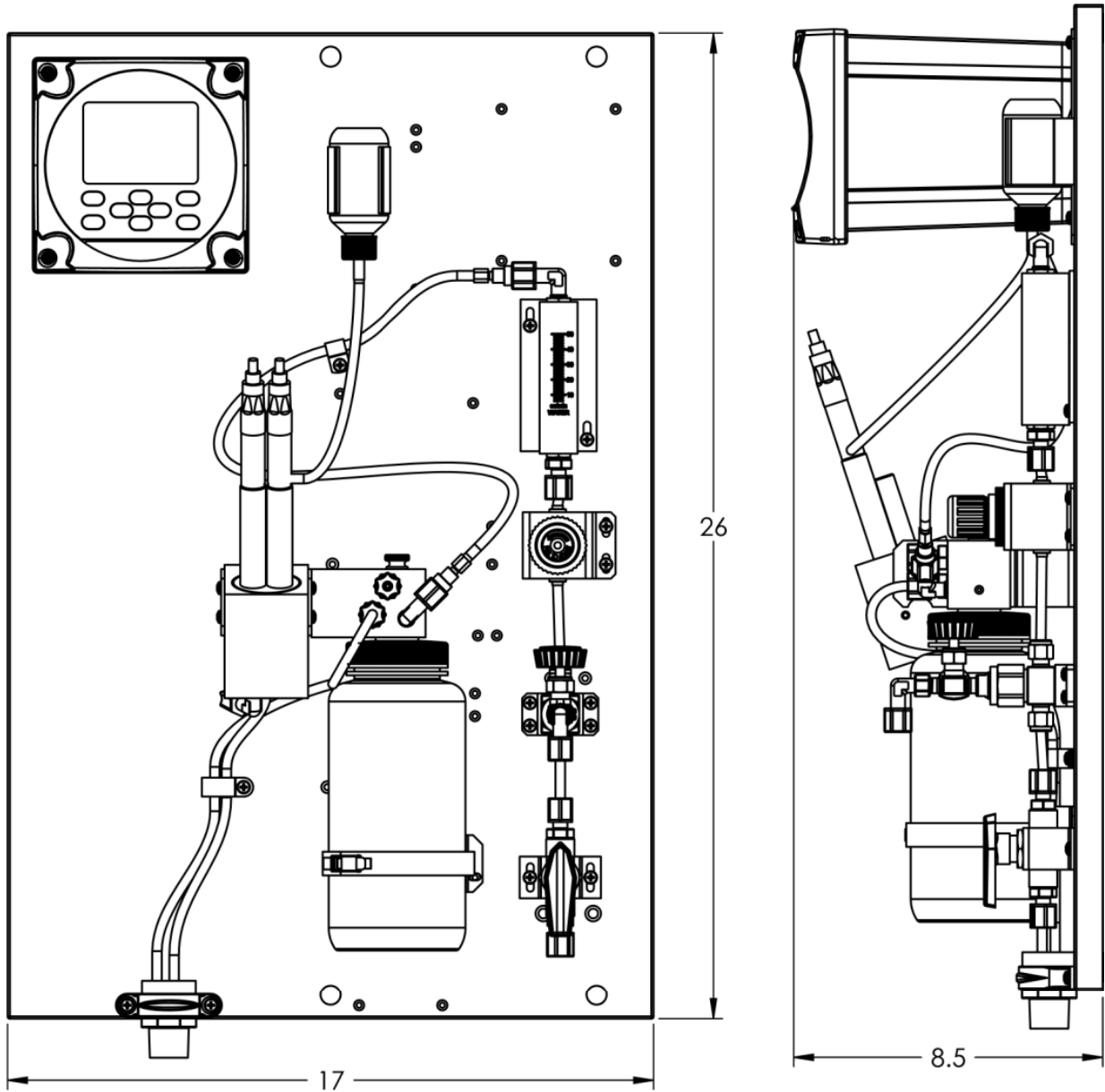

Chloride Default Values

S1: -.057 mV/ppb (at 0 °C)

S2 : -55mV/decade (at 0 °C)

Low Limit of S1: -1.1 mV/ppb

High Limit of S1: -0.30 mV/ppb

Low Limit of S2: -62 mV/ppb

High Limit of S2: -48mV/ppb

E_0 default: 188mV

Low limit of E_0 : 128mV

High limit of E_0 : + 248mV

Analyzer flow rate: 40 mL/minute

Standard concentration: 100 ppm

Standard 1 percent flow: 10.1%

Standard 1 range: x/100

Standard 2 percent flow: 10.2%

Standard 2 range: x/10

Specifications

Chloride Measurement	
Range	Chloride: 5 ppb to 10 ppm
Accuracy (with DYN calibration)	Chloride: $\pm 10\%$ or 5 ppb, whichever is greater
Resolution	2, 3 or 4 significant digits
Response Time	90% of final reading within 2 minutes of injecting a standard solution
Units Displayed	ppb, ppm (auto ranging)
Temperature Compensation	Automatic
mV Measurement	
Range	± 1999.9 mV
Resolution	0.1 mV
Relative Accuracy	$\pm (0.5 \text{ mV} + 0.1\%)$
LED Status Indicator	
Green	OK
Yellow	Warning
Red	Failure

Temperature Measurement	
Range	-10 to 120 °C
Resolution	0.1 °C
Relative Accuracy	± 0.5 °C
Failure Detection	Manual compensation
ATC Probe	30 K thermistor
Sample Conditions	
Temperature	5 to 45 °C, ideally < 35 °C
Total Alkalinity	Less than 50 ppm CaCO ₃
Inlet Pressure	8 to 100 psig
Flow Rate	40 mL/minute nominal set by pressure regulator
Sample Inlet	1/4" NPTF tube fitting
Sample Drain	3/4" NPT male
Grab Sampler	Optional
Reagent	Acid reagent
Display Features	
Type	Custom backlit LCD
Size	54 x 76 mm (2 1/8 in x 3 in)
Marquee	Temperature, operator prompts
Middle Line	Concentration, error codes
Lower Line	mV (selectable)
Text Display	Scrolling marquee for English language instructions on setup, calibration and diagnostics
Outputs	
Number of Analog Outputs	Two, one dedicated to chloride, one dedicated to temperature and shared ground
Analog Outputs	Galvanically isolated
Output Selections	0 to 20 mA or 4 to 20 mA
Programmable Range	Yes
Channel Assignments	Chloride and temperature
Relative Accuracy	± (0.05 mA + 0.5%)
Maximum Load	500 ohm or 10 V
Log and Linear Output Options	Yes, operator selectable
Analyzer Features	
Non-volatile Memory	Yes
Battery Backup (Replaceable)	Yes
Data Logging	Yes
Keypad	8 electromechanical keys with graphic overlay

Calibration	
Dynamic Dilution Calibration	Yes
Dynamic Dilution Calibration Points	3 points
Offline Calibration	Yes
Offline Calibration Points	1 point
Pre-programmed Standard Values	Yes
Custom Calibration	Operator programmable values
Operator Input	Dynamic dilution calibration, operator programmable, offline
Inputs (potentiometric)	
Ion Input	Chloride
Reference Input	Reference
Alarm Outputs	
Number of Relay Outputs	3
Maximum Relay Load	250 VAC/5 A, 30 VDC/5 A, resistive load only
Minimum Value Alarm	Yes
Maximum Value Alarm	Yes
Error Alarm	Yes
Calibration/offline Alarm	Yes
Programmable Min. and Max. Values	Yes
Software Features	
Self-test and Diagnostics	Yes
Real Time Clock	Yes
Password Protection	Yes
Reset Function	Yes
Programmable Alarms	High, low, error, calibration/offline
Measurement, Active	Signal noise, temperature
Calibration	Sensor response, drift, E_0 , slope, temperature
Environmental Operating Conditions	
Waterproof Enclosure	IP66 and NEMA 4X (2100 electronics module)
Overvoltage Category	II
Ambient Temperature	5 to 45 °C
Relative Humidity	Up to 95% non-condensing
Pollution Degree	2
Storage Temperature	-20 to 60 °C
Storage Humidity	Up to 95%, non-condensing
Altitude	Sea level to 2000 M

Miscellaneous	
Graphics	Custom chemical resistant
Cleaning Instructions	Wipe with damp cloth
Case Color	Black
Case Material	Valox 364
Warranty	12 months from date of installation or 18 months from date of shipment, whichever is earlier
Service Policy	Field service and factory
User Guide	CD/printed/web
Regulatory and Safety	CE, CSA, FCC class A limits
Physical Size of Analyzer	65 x 45 x 27 cm (26 x 17 x 11 inch) Fits on 1818A0 panel mounting footprint Weight: 22.7 kg (50 lbs)
Physical Size of Electronics Module	144 x 144 x 187 mm (5.67 x 5.67 x 7.36 inch) Weight: 1.7 kg (3.75 lbs)
Power Input	100 to 120 V, 200 mA or 200 to 240 V, 100 mA 50 / 60 Hz
Protection from Electric shock	 Class 2
Shock and Vibration	
Vibration, Shipping/handling	0 to 60 Hz @ 1 G Load
Shock, Drop Test In Packaging	36" on all sides and corners

Ordering Information

Cat. No.	Description
2117LL	Chloride Analyzer Package Only - includes chloride analyzer with chloride sensing electrode (100025), reference electrode (100057), ATC Probe (2100TP), 115 volt chiller (2117CH115) and CD user guide
2117LLEN	Chloride Analyzer with Protective Enclosure Package - includes chloride analyzer with chloride sensing electrode (100025), reference electrode (100057), ATC Probe (2100TP), 115 volt chiller (2117CH115) and CD user guide
2117LL230	Chloride Analyzer Package Only - includes chloride analyzer with chloride sensing electrode (100025), reference electrode (100057), ATC Probe (2100TP), 230 volt chiller (2117CH230) and CD user guide
2117LLEN230	Chloride Analyzer with Protective Enclosure Package - includes chloride analyzer with chloride sensing electrode (100025), reference electrode (100057), ATC Probe (2100TP), 230 volt chiller (2117CH230) and CD user guide
100025	Chloride Electrode Screwcap
100057	Reference Electrode Screwcap
941707	100 ppm Chloride standard, 475ml (1 pint bottle)
1817CAL	Kit contains a Dynamic Calibrator (CML 15DC15) & 100 ppm Standard (CML 941707)
182011	Acid reagent for 60 days operation (one liter bottle with two foot length of tubing and o-rings)

Accessory Options

Cat. No.	Description
2100EN	Protective enclosure for use with 2118XP oxygen scavenger analyzer
180029	Electronic test kit for troubleshooting 2100 series analyzers
2100PH2	Second channel module for pH/ORP
2100CD2	Second channel module for conductivity

Service Parts

Cat. No.	Description
100025	Chloride Electrode Screwcap
100057	Reference Electrode Screwcap
900063	Reference electrode filling solution, 5 x 60 mL (2 oz) bottles, for use with 100057 reference electrode
181060	Diffusing tubing, four 2 ft. lengths
182011	* Acid reagent for 60 days operation (one liter bottle) with 2 foot length thinwalled tubing and O-rings
941707	100 ppm chloride standard, 1 pint (475 mL) bottle
15DC15	Dynamic calibrator for performing three point calibration on 1817LL, includes syringe kits (150096 and 180096) and mounting bracket, 115 V
15DC20	Dynamic calibrator for performing three point calibration on 1817LL, includes syringe kits (150096 and 180096) and mounting bracket, 220 V
180096	Syringe kit with 20 cc syringe for use with dynamic calibrator during three point calibration on 1817LL
1817CAL	1817LL calibration kit, includes dynamic calibrator (15DC15) and 100 ppm chloride standard (941707)
181170	Inlet filters, stainless steel, 60 micron filters with gaskets, pack of 2
181171	Filter gaskets, for use with 181170 inlet filters, pack of 2
217135-A01	Connector Block Assembly with thumb screw and injection port
201815-001	Standard Injection Port
1SMXXX	Thumbscrew (on the fluid block) with three washers

Field Replaceable Parts

Cat. No.	Description
2117CH115	Chiller, 115V
2117CH230	Chiller, 230V
2117FP	Fluidics panel assembly, 2117LL
2100NV	Inlet valve assembly
2100BV	Bypass/needle valve assembly
2100RG	Regulator assembly
2100FM	Flow meter assembly

2100RT	Restrictor tube assembly
702310-A03	Reagent bottle adapter assembly
2100AF	Air filter assembly
2100TG	Tygon tubing (4 ft)
181170	(2) Inlet filters
2100EC	(2) x 1 meter electrode cables for 100025 and 100057 electrodes
2100FK115	Fuse kit assembly, 115 V
2100FK230	Fuse kit assembly, 230 V
2100PS	Power supply assembly
2117LLEP	2117LL electronics faceplate
2117LLSK	Service Kit – includes (1) electronics faceplate (2117LLEP), (1) air pump assembly (2100PA), (1) regulator assembly (2100RG), (2) electrode cable with gland assemblies for sensing and reference electrodes, (1) power supply assembly (2100PS) and (1) fuse kit assembly (2100FK115 and 2100FK230)



*Thermo Fisher Scientific
Water Analysis Instruments
Chelmsford, MA USA
Quality Management System
Registered to ISO 9001*

thermofisher.com/Water

© 2017 Thermofisher Scientific Inc. All Rights Reserved Modbus is a registered trademark of Schneider Electric. Kimwipes is a registered trademark of Kimberly-clark and its affiliates. Certified System Standards Mark logo is a trademark of SAI global. All other trademarks are the property of Thermo Fisher Scientific inc. & its subsidiaries.

Water Analysis Instruments

North America

Toll Free: 1-800-225-1480
Tel: 1-978-232-6000
info.water@thermofisher.com

Germany

Tel: (49) 6184-90-6000
info.water.uk@thermofisher.com

India

Tel: (91) 22-4157-8800
wai.asia@thermofisher.com

Japan

Tel: (81) 045-453-9175
wai.asia@thermofisher.com

China

Tel: (86) 21-68654588
wai.asia@thermofisher.com

Singapore

Tel: (65) 6778-6876
wai.asia@thermofisher.com

Australia

Tel: (613) 9757-4300
In Australia: (1300) 735-295
InfoWaterAu@thermofisher.com